

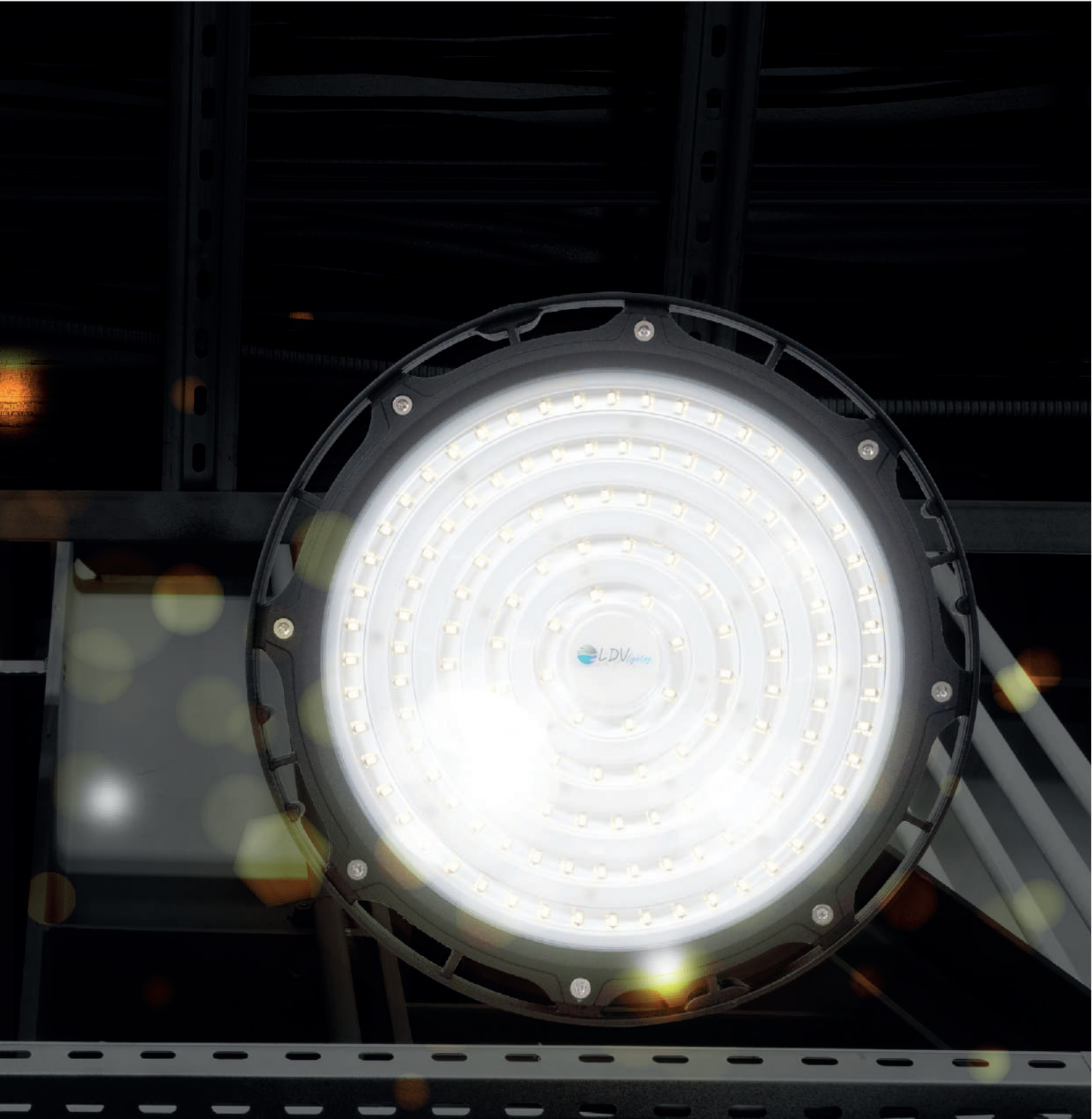

CAMPANAS LED
CAMPÂNULA LED



156

CAMPANAS LED

CAMPÂNULA LED



125lm/W

CAMPANA INDUSTRIAL LED *SILVER* CAMPÂNULA LED *SILVER*

LUMILEDS
The Brighter Choice
LUXEON 3030 2d

100W

9610006CW 5700 K 12500 Lm
9610006NW 4000 K 12300 Lm

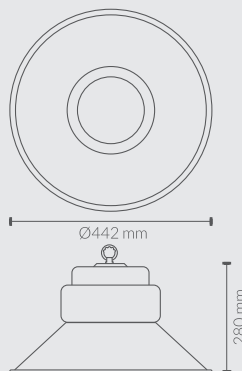

3 ANOS
Garantía

PROTECCIONES DEL DRIVER PROTEÇÕES DO DRIVER

OVP	Protección contra sobretensión <i>Proteção contra sobretensão</i>
SCP	Protección contra cortocircuitos <i>Proteção contra curto-circuito</i>
OPP	Protección de sobrecarga <i>Proteção de sobrecarga</i>
OTP	Protección contra sobrecalentamiento <i>Proteção contra superaquecimento</i>





125lm/W



CAMPANA INDUSTRIAL LED *SILVER*
CAMPÂNULA LED *SILVER*



PROTECCIONES DEL DRIVER	
PROTEÇÕES DO DRIVER	
OVP	Protección contra sobretensión <i>Proteção contra sobretensão</i>
SCP	Protección contra cortocircuitos <i>Proteção contra curto-circuito</i>
OPP	Protección de sobrecarga <i>Proteção de sobrecarga</i>
OTP	Protección contra sobrecalentamiento <i>Proteção contra superaquecimento</i>

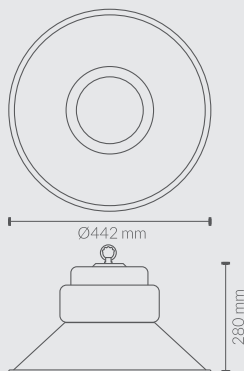

150W

9615006CW	5700 K	18750 Lm
9615006NW	4500 K	18450 Lm



CAMPANAS LED

CAMPÂNULA LED



CAMPANA INDUSTRIAL LED *SILVER* CAMPÂNULA LED *SILVER*

LUMILEDS
The Brighter Choice
LUXEON 3030 2d

125lm/W

3 ANOS
Garantía

200W

9620006CW
9620006NW

5700 K 25000 Lm
4500 K 24600 Lm

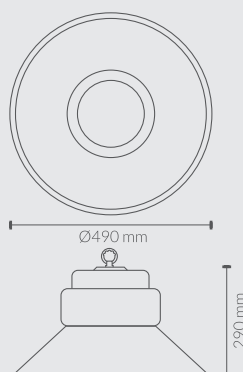

PROTECCIONES DEL DRIVER

PROTEÇÕES DO DRIVER

OVP	Protección contra sobretensión <i>Proteção contra sobretensão</i>
SCP	Protección contra cortocircuitos <i>Proteção contra curto-circuito</i>
OPP	Protección de sobrecarga <i>Proteção de sobrecarga</i>
OTP	Protección contra sobrecalentamiento <i>Proteção contra superaquecimento</i>



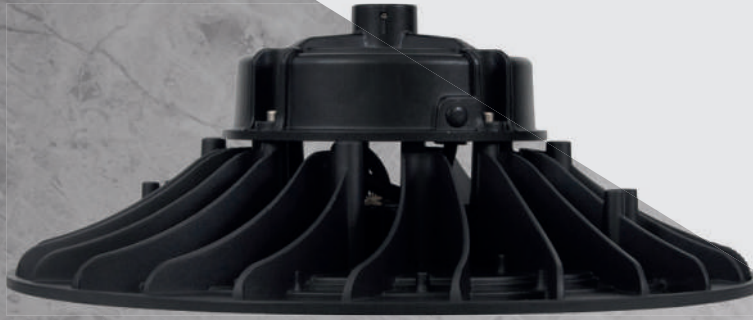

135lm/W



CAMPANA LED UFO *PLUS*
CAMPÂNULA LED UFO *PLUS*



PROTECCIONES DEL DRIVER	
PROTEÇÕES DO DRIVER	
OVP	Protección contra sobretensión <i>Proteção contra sobretensão</i>
SCP	Protección contra cortocircuitos <i>Proteção contra curto-circuito</i>
OPP	Protección de sobrecarga <i>Proteção de sobrecarga</i>
OTP	Protección contra sobrecalentamiento <i>Proteção contra superaquecimento</i>

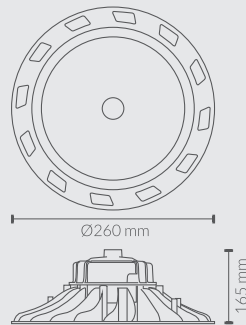

100W



9610001209CW	5700 K	13500 Lm
9610001209NW	4000 K	13300 Lm



9610001212CW	5700 K	13500 Lm
9610001212NW	4000 K	13300 Lm



CAMPANAS LED

CAMPÂNULA LED



CAMPANA LED UFO *PLUS*

CAMPÂNULA LED UFO *PLUS*

135lm/W



LUMILEDS
The Brighter Choice
LUXEON 3030 2d

150W



9615001209CW 5700 K 20250 Lm
9615001209NW 4000 K 19950 Lm



9615001212CW 5700 K 20250 Lm
9615001212NW 4000 K 19950 Lm

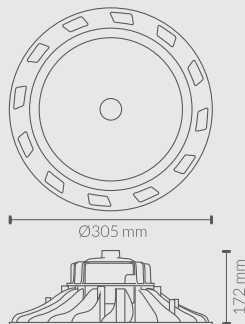

PROTECCIONES DEL DRIVER
PROTEÇÕES DO DRIVER

- OVP Protección contra sobretensión / Proteção contra sobretensão
- SCP Protección contra cortocircuitos / Proteção contra curto-circuito
- OPP Protección de sobrecarga / Proteção de sobrecarga
- OTP Protección contra sobrecalentamiento / Proteção contra superaquecimento

- 85/265 VAC
- SMD X240
- CRI >80
- PF 0,9
- 4KV
- 20°/50°
- 45000 HRS
- 35000 ON/OFF
- IP 65
- IK 08
- ALUMINIO
- 2,37 kg



135lm/W



CAMPANA LED UFO *PLUS*
CAMPÂNULA LED UFO *PLUS*



PROTECCIONES DEL DRIVER	
PROTEÇÕES DO DRIVER	
OVP	Protección contra sobretensión <i>Proteção contra sobretensão</i>
SCP	Protección contra cortocircuitos <i>Proteção contra curto-circuito</i>
OPP	Protección de sobrecarga <i>Proteção de sobrecarga</i>
OTP	Protección contra sobrecalentamiento <i>Proteção contra superaquecimento</i>

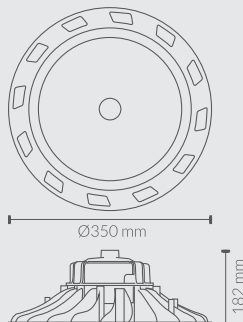

200W

9620001209CW	5700 K	27000 Lm
9620001209NW	4000 K	26600 Lm



9620001212CW	5700 K	27000 Lm
9620001212NW	4000 K	26600 Lm

-
-
-
-
-
-
-
-
-
-
-
-
-



CAMPANA LED UFO *PLUS*
CAMPÂNULA LED UFO *PLUS*

135lm/W

5 ANOS GARANTIA

LUMILEDS
The Brighter Choice
LUXEON 3030 2d

240W



9624001209CW 5700 K 32400 Lm
9624001209NW 4000 K 31920 Lm



9624001212CW 5700 K 32400 Lm
9624001212NW 4000 K 31920 Lm

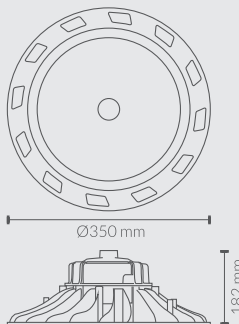

PROTECCIONES DEL DRIVER
PROTEÇÕES DO DRIVER

- OVP** Protección contra sobretensión
Proteção contra sobretensão
- SCP** Protección contra cortocircuitos
Proteção contra curto-circuito
- OPP** Protección de sobrecarga
Proteção de sobrecarga
- OTP** Protección contra sobrecalentamiento
Proteção contra superaquecimento

- 85/265 VAC
- SMD X320
- CRI >80
- PF 0,9
- 4KV
- 20°/50°
- 45000 HRS
- 35000 ON/OFF
- IP 65
- IK 08
- ALUMINIO
- 3,30 kg
- Earth symbol



145lm/W



PROTECCIONES DEL DRIVER
PROTEÇÕES DO DRIVER



- OVP Protección contra sobretensión
Proteção contra sobretensão
- SCP Protección contra cortocircuitos
Proteção contra curto-circuito
- OPP Protección de sobrecarga
Proteção de sobrecarga
- OTP Protección contra sobrecalentamiento
Proteção contra superaquecimento

CAMPANA LED UFO *MAX*
CAMPÂNULA LED UFO *MAX*



100W

9610001CW	5700 K	14500 Lm
9610001NW	4000 K	14300 Lm

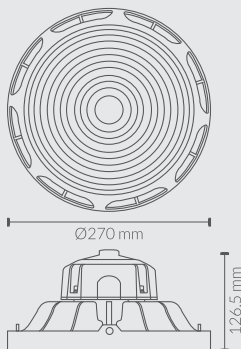

-
-
-
-
-
-
-
-
-
-
-
-
-
-

CAMPANAS LED

CAMPÂNULA LED



CAMPANA LED UFO *MAX* CAMPÂNULA LED UFO *MAX*

145lm/W



LUMILEDS
The Brighter Choice
LUXEON 3030 2d



150W

9615001CW	5700 K	21750 Lm
9615001NW	4000 K	21450 Lm

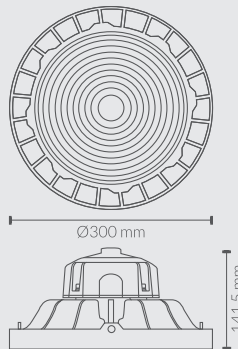

PROTECCIONES DEL DRIVER PROTEÇÕES DO DRIVER



OVP	Protección contra sobretensión <i>Proteção contra sobretensão</i>
SCP	Protección contra cortocircuitos <i>Proteção contra curto-circuito</i>
OPP	Protección de sobrecarga <i>Proteção de sobrecarga</i>
OTP	Protección contra sobrecalentamiento <i>Proteção contra superaquecimento</i>

-
-
-
-
-
-
-
-
-
-
-
-
-
-

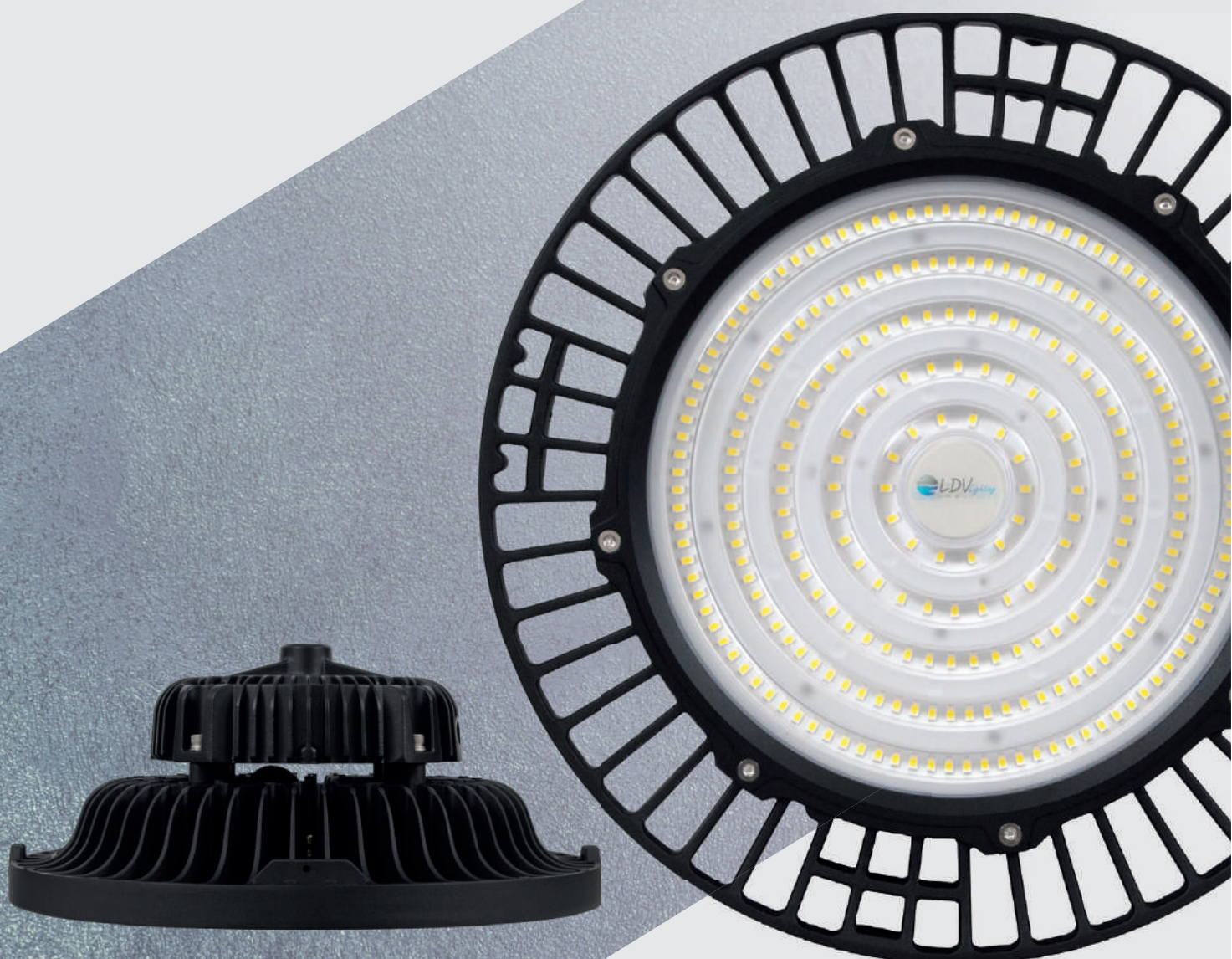

145lm/W



CAMPANA LED UFO *MAX*
CAMPÂNULA LED UFO *MAX*



200W

9620001CW	5700 K	29000 Lm
9620001NW	4000 K	28600 Lm

PROTECCIONES DEL DRIVER
PROTEÇÕES DO DRIVER

MW
MEAN WELL

- OVP** Protección contra sobretensión
Proteção contra sobretensão
- SCP** Protección contra cortocircuitos
Proteção contra curto-circuito
- OPP** Protección de sobrecarga
Proteção de sobrecarga
- OTP** Protección contra sobrecalentamiento
Proteção contra superaquecimento

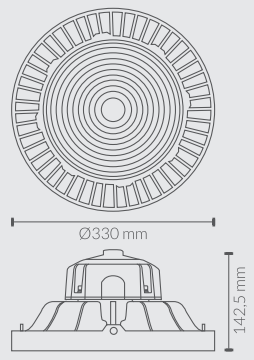

-
-
-
-
-
-
-
-
-
-
-
-
-
-

CAMPANAS LED

CAMPÂNULA LED



CAMPANA LED UFO *MAX* CAMPÂNULA LED UFO *MAX*

145lm/W

5 ANOS *Garantía*

LUMILEDS
The Brighter Choice
LUXEON 3030 2d

MW
MEAN WELL

240W

9624001CW 5700 K 34800 Lm
9624001NW 4000 K 34320 Lm

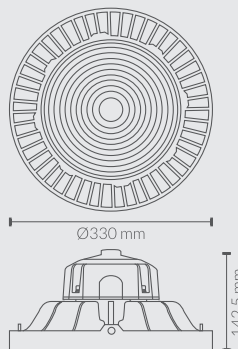

PROTECCIONES DEL DRIVER
PROTEÇÕES DO DRIVER

MW
MEAN WELL

- OVP** Protección contra sobretensión
Proteção contra sobretensão
- SCP** Protección contra cortocircuitos
Proteção contra curto-circuito
- OPP** Protección de sobrecarga
Proteção de sobrecarga
- OTP** Protección contra sobrecalentamiento
Proteção contra superaquecimento

- 90/305 VAC
- SMD X294
- 90°
- CRI >80
- PF 0,9
- 6KV
- 20°/50°
- 55000 HRS
- 40000 ON/OFF
- IP 65
- IK 08
- ALUMINIO
- 5,00 kg
- Grounding symbol

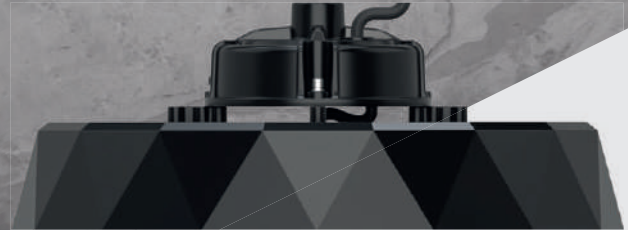

165lm/W



5 AÑOS GARANTÍA

CAMPANA LED UFO *ASTRAL* REGULABLE
0-10v/PWM/ Resistor

CAMPÂNULA LED UFO *ASTRAL* REGULÁVEL
0-10v/PWM/Resistor



100W



9610001357CW	5700 K	16500 Lm
9610001350CW	5000 K	16300 Lm
9610001340NW	4000 K	16100 Lm

100W

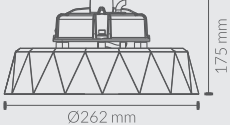

150W

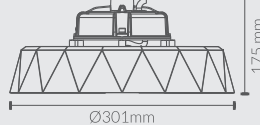

200W
240W

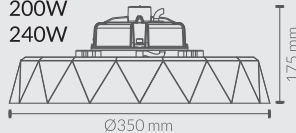

150W



9615001357CW	5700 K	24750 Lm
9615001350CW	5000 K	24450 Lm
9615001340NW	4000 K	24150 Lm



200W



9620001357CW	5700 K	33000 Lm
9620001350CW	5000 K	32600 Lm
9620001340NW	4000 K	32200 Lm



240W



9624001357CW	5700 K	39600 Lm
9624001350CW	5000 K	39120 Lm
9624001340NW	4000 K	38640 Lm

PROTECCIONES DEL DRIVER

PROTEÇÕES DO DRIVER



OVP	Protección contra sobretensión <i>Proteção contra sobretensão</i>
SCP	Protección contra cortocircuitos <i>Proteção contra curto-circuito</i>
OPP	Protección de sobrecarga <i>Proteção de sobrecarga</i>
OTP	Protección contra sobrecalentamiento <i>Proteção contra superaquecimento</i>



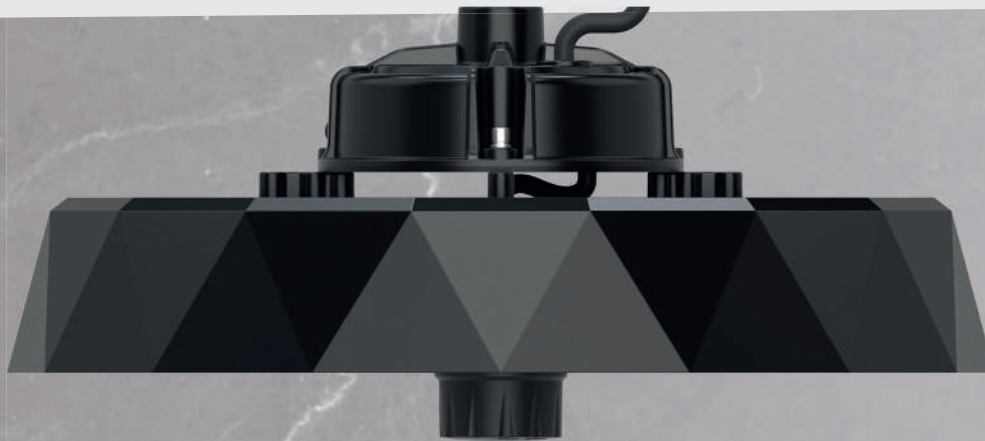

CAMPANA LED UFO *ASTRAL* REGULABLE
C/SENSOR Y FUNCIONAMIENTO
ON/STAND-BY/OFF

CAMPÂNULA LED UFO *ASTRAL* C/ SENSOR OPERAÇÃO ON/STAND-BY/OFF

165lm/W



LUMILEDS
The Brighter Choice
LUXEON 3030 2d

SOSEN
LED DRIVER

100W

9610001357SCW	5700 K	16500 Lm
9610001350SCW	5000 K	16300 Lm
9610001340SNW	4000 K	16100 Lm

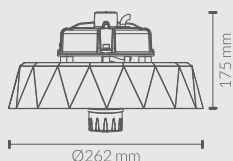

960005
MANDO DE CONTROL
REMOTO HD05R
COMANDO DE CONTROLE
REMOTO HD05R

PROTECCIONES DEL DRIVER

PROTEÇÕES DO DRIVER



OVP	Protección contra sobretensión <i>Proteção contra sobretensão</i>
SCP	Protección contra cortocircuitos <i>Proteção contra curto-circuito</i>
OPP	Protección de sobrecarga <i>Proteção de sobrecarga</i>
OTP	Protección contra sobrecalentamiento <i>Proteção contra superaquecimento</i>

HAISEN ESPECIFICACIONES SENSOR
ESPECIFICAÇÕES DO SENSOR



SENSOR
HD06VCRH 7B

Tipo de Sensor <i>Tipo de Sensor</i>	Microondas <i>Microondas</i>	Tiempo de encendido <i>Tempo de ignição</i>	5s, 30s, 1min, 3min, 5min, 10min, 20min, 30min.
Marca <i>Marca</i>	HAISEN	Regulación de Luminosidad en stand by <i>Controlo de luminosidade em stand-by</i>	10%, 20%, 30%, 50%
Modelo <i>Modelo</i>	HD06VCRH 7B	Tiempo de encendido en stand by <i>Tempo de ignição</i>	0s, 1min, 30min, infinito.
Modo de Trabajo <i>Modo de trabalho</i>	Función on/off <i>Função liga / desliga</i> Función on/stand-by <i>Função On / Stand-by</i> Función on/stand-by/off <i>Função On / Stand-by / Off</i>	Área de detección <i>Área de detecção</i>	100%, 75%, 50%, 25%
Opción de configuración <i>Opção de configuração</i>	Si <i>Sim</i>	Sensor de luminosidad <i>Sensor de luminosidade</i>	2lux, 10lux, 30lux, 50lux, 80lux, 120lux, deshabilitado (<i>desativado</i>)
Sistema de Control <i>Sistema de controlo</i>	Control remoto <i>Controlo remoto</i>	Rango de detección <i>Faixa de detecção</i>	D12mts (montaje en techo) <i>D12mts (montagem no teto)</i>
Regulación de Luminosidad <i>Controlo de luminosidade</i>	0% (0.5V) - 100% (10V)	Altura de montaje <i>Altura de montagem</i>	max. 10mts



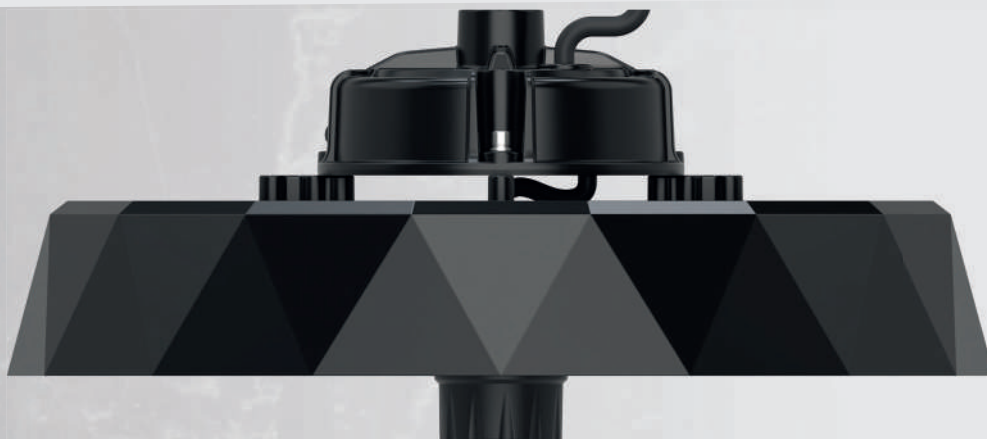

165lm/W



CAMPANA LED UFO *ASTRAL* REGULABLE
C/SENSOR Y FUNCIONAMIENTO
ON/STAND-BY/OFF

CAMPÂNULA LED UFO *ASTRAL* C/ SENSOR OPERAÇÃO ON/STAND-BY/OFF



PROTECCIONES DEL DRIVER
PROTEÇÕES DO DRIVER

OVP	Protección contra sobretensión <i>Proteção contra sobretensão</i>
SCP	Protección contra cortocircuitos <i>Proteção contra curto-circuito</i>
OPP	Protección de sobrecarga <i>Proteção de sobrecarga</i>
OTP	Protección contra sobrecalentamiento <i>Proteção contra superaquecimento</i>



960005
MANDO DE CONTROL
REMOTO HD05R
COMANDO DE CONTROLE
REMOTO HD05R

150W

9615001357SCW	5700 K	24750 Lm
9615001350SCW	5000 K	24450 Lm
9615001340SNW	4000 K	24150 Lm

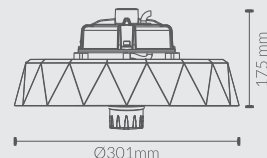

HAISEN ESPECIFICACIONES SENSOR
ESPECIFICAÇÕES DO SENSOR

Tipo de Sensor <i>Tipo de Sensor</i>	Microondas <i>Microondas</i>
Marca <i>Marca</i>	HAISEN
Modelo <i>Modelo</i>	HD06VCRH 7B
Modo de Trabajo <i>Modo de trabalho</i>	Función on/off <i>Função liga / desliga</i> Funcion on/stand-by <i>Função On / Stand-by</i> Funcion on/stand-by/off <i>Função On / Stand-by / Off</i>
Opción de configuración <i>Opção de configuração</i>	Si <i>Sim</i>
Sistema de Control <i>Sistema de controle</i>	Control remoto <i>Controle remoto</i>
Regulación de Luminosidad <i>Controlo de luminosidade</i>	0% (0.5V) - 100% (10V)

Tiempo de encendido <i>Tempo de ignição</i>	5s, 30s, 1min, 3min, 5min, 10min, 20min, 30min.
Regulación de Luminosidad en stand by <i>Controlo de luminosidade em stand-by</i>	10%, 20%, 30%, 50%
Tiempo de encendido en stand by <i>Tempo de ignição</i>	0s, 1min, 30min, infinito.
Área de detección <i>Área de deteção</i>	100%, 75%, 50%, 25%
Sensor de luminosidad <i>Sensor de luminosidade</i>	2lux, 10lux, 30lux, 50lux, 80lux, 120lux, deshabilitado (<i>desativado</i>)
Rango de detección <i>Faixa de deteção</i>	D12mts (montaje en techo) <i>D12mts (montagem no teto)</i>
Altura de montaje <i>Altura de montagem</i>	max. 10mts



SENSOR
HD06VCRH 7B



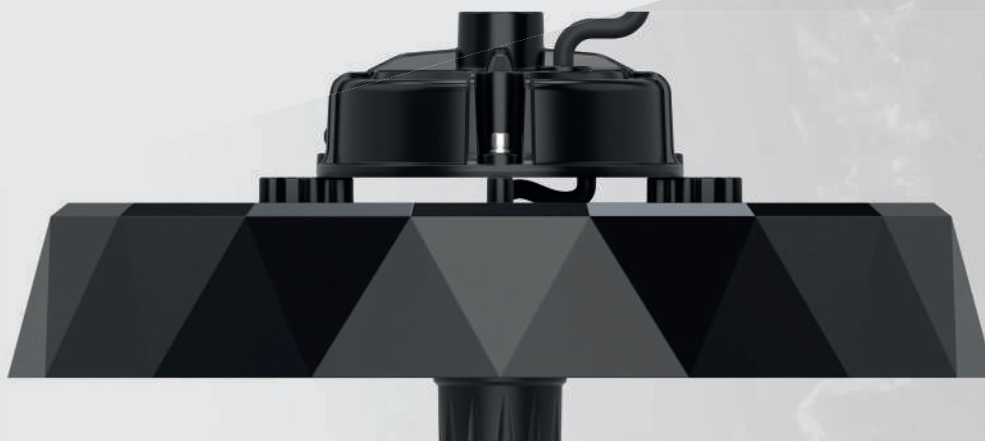

CAMPANA LED UFO *ASTRAL* REGULABLE
C/SENSOR Y FUNCIONAMIENTO
ON/STAND-BY/OFF

165lm/W



CAMPÂNULA LED UFO *ASTRAL* C/ SENSOR OPERAÇÃO ON/STAND-BY/OFF



200W

9620001357SCW	5700 K	33000 Lm
9620001350SCW	5000 K	32600 Lm
9620001340SNW	4000 K	32200 Lm

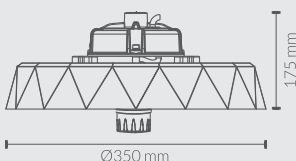

960005
MANDO DE CONTROL
REMOTO HD05R
COMANDO DE CONTROLE
REMOTO HD05R

PROTECCIONES DEL DRIVER

PROTEÇÕES DO DRIVER



OVP	Protección contra sobretensión <i>Proteção contra sobretensão</i>
SCP	Protección contra cortocircuitos <i>Proteção contra curto-circuito</i>
OPP	Protección de sobrecarga <i>Proteção de sobrecarga</i>
OTP	Protección contra sobrecalentamiento <i>Proteção contra superaquecimento</i>

HAISEN® ESPECIFICACIONES SENSOR
ESPECIFICAÇÕES DO SENSOR



SENSOR
HD06VCRH 7B

Tipo de Sensor <i>Tipo de Sensor</i>	Microondas <i>Microondas</i>	Tiempo de encendido <i>Tempo de ignição</i>	5s, 30s, 1min, 3min, 5min, 10min, 20min, 30min.
Marca <i>Marca</i>	HAISEN	Regulación de Luminosidad en stand by <i>Controlo de luminosidade em stand-by</i>	10%, 20%, 30%, 50%
Modelo <i>Modelo</i>	HD06VCRH 7B	Tiempo de encendido en stand by <i>Tempo de ignição</i>	0s, 1min, 30min, infinito.
Modo de Trabajo <i>Modo de trabalho</i>	Función on/off <i>Função liga / desliga</i> Función on/stand-by <i>Função On / Stand-by</i> Función on/stand-by/off <i>Função On / Stand-by / Off</i>	Área de detección <i>Área de deteção</i>	100%, 75%, 50%, 25%
Opción de configuración <i>Opção de configuração</i>	Si <i>Sim</i>	Sensor de luminosidad <i>Sensor de luminosidade</i>	2lux, 10lux, 30lux, 50lux, 80lux, 120lux, deshabilitado (<i>desativado</i>)
Sistema de Control <i>Sistema de controlo</i>	Control remoto <i>Controlo remoto</i>	Rango de detección <i>Faixa de deteção</i>	D12mts (montaje en techo) <i>D12mts (montagem no teto)</i>
Regulación de Luminosidad <i>Controlo de luminosidade</i>	0% (0.5V) - 100% (10V)	Altura de montaje <i>Altura de montagem</i>	max. 10mts



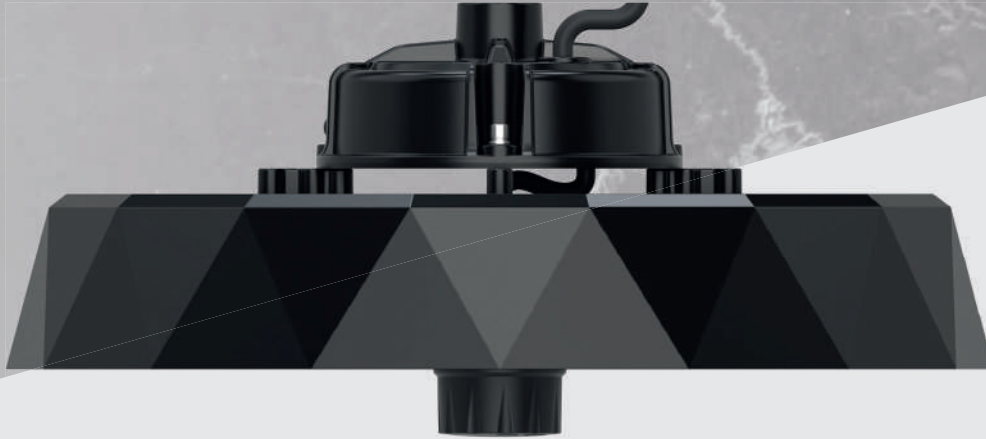

165lm/W



CAMPANA LED UFO *ASTRAL* REGULABLE
C/SENSOR Y FUNCIONAMIENTO
ON/STAND-BY/OFF

CAMPÂNULA LED UFO *ASTRAL* C/ SENSOR OPERAÇÃO ON/STAND-BY/OFF



PROTECCIONES DEL DRIVER

PROTEÇÕES DO DRIVER



OVP	Protección contra sobretensión <i>Proteção contra sobretensão</i>
SCP	Protección contra cortocircuitos <i>Proteção contra curto-circuito</i>
OPP	Protección de sobrecarga <i>Proteção de sobrecarga</i>
OTP	Protección contra sobrecalentamiento <i>Proteção contra superaquecimento</i>



960005

MANDO DE CONTROL
REMOTO HD05R
COMANDO DE CONTROLE
REMOTO HD05R

240W

9624001357SCW	5700 K	39600 Lm
9624001350SCW	5000 K	39120 Lm
9624001340SNW	4000 K	38640 Lm

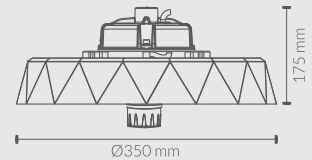

ESPECIFICACIONES SENSOR

ESPECIFICAÇÕES DO SENSOR

Tipo de Sensor <i>Tipo de Sensor</i>	Microondas <i>Microondas</i>	Tiempo de encendido <i>Tempo de ignição</i>	5s, 30s, 1min, 3min, 5min, 10min, 20min, 30min.
Marca <i>Marca</i>	HAISEN	Regulación de Luminosidad en stand by <i>Controlo de luminosidade em stand-by</i>	10%, 20%, 30%, 50%
Modelo <i>Modelo</i>	HD06VCRH 7B	Tiempo de encendido en stand by <i>Tempo de ignição</i>	0s, 1min, 30min, infinito.
Modo de Trabajo <i>Modo de trabalho</i>	Función on/off <i>Função liga / desliga</i> Funcion on/stand-by <i>Função On / Stand-by</i> Funcion on/stand-by/off <i>Função On / Stand-by / Off</i>	Área de detección <i>Área de detecção</i>	100%, 75%, 50%, 25%
Opción de configuración <i>Opção de configuração</i>	Si <i>Sim</i>	Sensor de luminosidad <i>Sensor de luminosidade</i>	2lux, 10lux, 30lux, 50lux, 80lux, 120lux, deshabilitado (<i>desativado</i>)
Sistema de Control <i>Sistema de controlo</i>	Control remoto <i>Controlo remoto</i>	Rango de detección <i>Faixa de detecção</i>	D12mts (montaje en techo) <i>D12mts (montagem no teto)</i>
Regulación de Luminosidad <i>Controlo de luminosidade</i>	0% (0.5V) - 100% (10V)	Altura de montaje <i>Altura de montagem</i>	max. 10mts



ACCESORIOS UFO *MAX*
ACESSÓRIOS UFO *MAX*

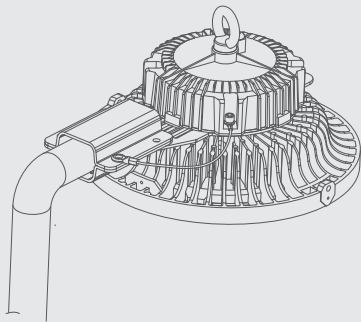

ADAPTADOR SOPORTE BRAZO DE COLUMNA O BÁCULOS
ADAPTADOR DE SUPORTE PARA BRAÇO DE COLUNA OU HASTE

960000

Modo de instalación: COLUMNA/ BÁCULO D50-65mm

Modo de instalação: COLUNA / HASTE D50-65mm



SOPORTE LIRA PARA UFO MAX
SUPORTE DE LIRA PARA UFO

960001 - 100W

Modo de instalación: PARED / TECHO

Modo de instalação: PAREDE / TETO



960002 - 150W

Modo de instalación: PARED / TECHO

Modo de instalação: PAREDE / TETO

960003 - 200W / 240W

Modo de instalación: PARED / TECHO

Modo de instalação: PAREDE / TETO

Lira con goniómetro

Lira com goniômetro



ÂNGULO 15°
ÂNGULO 15°

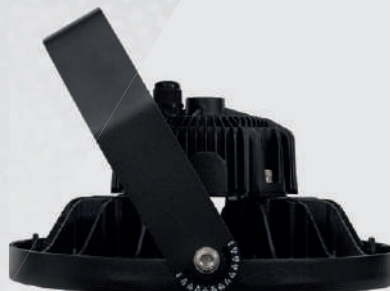

ÂNGULO 60°
ÂNGULO 60°



ÂNGULO 90°
ÂNGULO 90°



LUMINARIAS VIALES
LUMINÁRIAS PARA EXTERIOR

R Ral 9007 Aluminio Gris
Ral 9007 Alumínio Cinza



Perfil recto / Perfil reto



Perfil 90° / Perfil 90°



DISEÑADO Y ENSAMBLADO EN ESPAÑA



Braço direccional para montagem em bastão ou columna.

Braço direccional para montagem em poste ou coluna.

LUMINARIA VIAL GADIR

LUMINÁRIAS DE EXTERIOR GADIR

LUMILEDS
The Brighter Choice
SMD2835



145lm/W



40W

71403010CW	5700 K	5800 Lm
71403010NW	4000 K	5720 Lm
71403010WW	2700 K	5640 Lm



71403070CW	5700 K	5800 Lm
71403070NW	4000 K	5720 Lm
71403070WW	2700 K	5640 Lm



80W

71803010CW	5700 K	11600 Lm
71803010NW	4000 K	11440 Lm
71803010WW	2700 K	11280 Lm



71803070CW	5700 K	11600 Lm
71803070NW	4000 K	11440 Lm
71803070WW	2700 K	11280 Lm

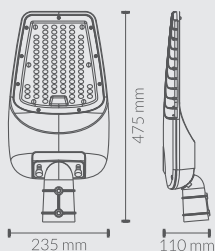

60W

71603010CW	5700 K	8700 Lm
71603010NW	4000 K	8580 Lm
71603010WW	2700 K	8460 Lm



71603070CW	5700 K	8700 Lm
71603070NW	4000 K	8580 Lm
71603070WW	2700 K	8460 Lm



Opcional:

Opcional

710000 Protector sobretensión 10kv.
Protetor sobretensão 10kv.

Otros acabados Ral bajo pedido.
Outros acabamentos Ral sob consulta.

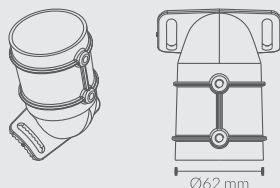

PROTECCIONES DEL DRIVER

PROTEÇÕES DO DRIVER

OVP	Protección contra sobretensión Proteção contra sobretensão
SCP	Protección contra cortocircuitos Proteção contra curto-circuito
OTP	Protección contra sobrecalentamiento Proteção contra superaquecimento





DISEÑADO Y
ENSAMBLADO
ESPAÑA

5 AÑOS
Garantía

145lm/W

HASTA
10 KV

LUMILEDS
The Brighter Choice
SMD2835

LUMINARIA VIAL *GADIR*
LUMINÁRIAS DE EXTERIOR *GADIR*

100W

711003010CW	5700 K	14500 Lm
711003010NW	4000 K	14300 Lm
711003010WW	2700 K	14100 Lm
711003070CW	5700 K	14500 Lm
711003070NW	4000 K	14300 Lm
711003070WW	2700 K	14100 Lm

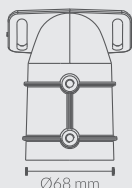
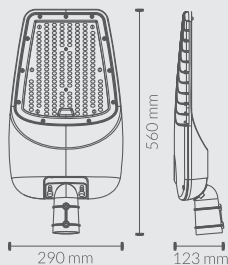

120W

711203010CW	5700 K	17400 Lm
711203010NW	4000 K	17160 Lm
711203010WW	2700 K	16920 Lm
711203070CW	5700 K	17400 Lm
711203070NW	4000 K	17160 Lm
711203070WW	2700 K	16920 Lm



140W

711403010CW	5700 K	20300 Lm
711403010NW	4000 K	20020 Lm
711403010WW	2700 K	19740 Lm
711403070CW	5700 K	20300 Lm
711403070NW	4000 K	20020 Lm
711403070WW	2700 K	19740 Lm



PROTECCIONES DEL DRIVER
PROTEÇÕES DO DRIVER

OVP	Protección contra sobretensión <i>Proteção contra sobretensão</i>
SCP	Protección contra cortocircuitos <i>Proteção contra curto-circuito</i>
OTP	Protección contra sobrecalentamiento <i>Proteção contra superaquecimento</i>

Opcional:

Opcional

710000 Protector sobretensión 10kv.
Protetor sobretensão 10kv.

Otros acabados Ral bajo pedido.
Outros acabamentos Ral sob consulta.



LUMINARIAS VIALES

LUMINÁRIAS PARA EXTERIOR



Perfil recto / Perfil reto



Perfil 90° / Perfil 90°



15°

Braço direccional para montaje en baculo o columna.

Braço direccional para montagem em poste ou coluna.

LUMINARIA VIAL *GADIR* REGULABLE 0-10V/PWM/DIM-TO-OFF LUMINÁRIAS DE EXTERIOR *GADIR* REGULÁVEL 0-10V/PWM/DIM-TO-OFF



145lm/W



MOSO



40W

71403010CWR	5700 K	5800 Lm
71403010NWR	4000 K	5720 Lm
71403010WWR	2700 K	5640 Lm



71403070CWR	5700 K	5800 Lm
71403070NWR	4000 K	5720 Lm
71403070WWR	2700 K	5640 Lm



60W

71603010CWR	5700 K	8700 Lm
71603010NWR	4000 K	8580 Lm
71603070WWR	2700 K	8460 Lm



71603070CWR	5700 K	8700 Lm
71603070NWR	4000 K	8580 Lm
71603010WWR	2700 K	8460 Lm



80W

71803010CWR	5700 K	11600 Lm
71803010NWR	4000 K	11440 Lm
71803010WWR	2700 K	11280 Lm



71803070CWR	5700 K	11600 Lm
71803070NWR	4000 K	11440 Lm
71803070WWR	2700 K	11280 Lm

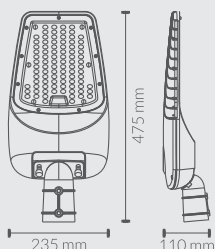

Opcional:

Opcional

710000 Protector sobretensión 10kv.
Protetor sobretensão 10kv.

Otros acabados Ral bajo pedido.
Outros acabamentos Ral sob consulta.

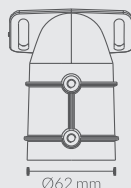

DRIVER REGULABLE MOSO X6-75
DRIVER REGULÁVEL MOSO X6-75

MOSO

Regulación 0-10 vac, PWM, dim to off
Regulação 0-10 vac, PWM, dim to off

Programación offline
Programação off-line

Temporizador
Cronómetro

PROTECCIONES DEL DRIVER
PROTEÇÕES DO DRIVER

OVP	Protección contra sobretensión Proteção contra sobretensão
SCP	Protección contra cortocircuitos Proteção contra curto-circuito
OTP	Protección contra sobrecalentamiento Proteção contra superaquecimento





R Ral 9007 Aluminio Gris
Ral 9007 Alumínio Cinza



145lm/W



LUMINARIA VIAL *QADIR* REGULABLE
0-10V/PWM/DIM-TO-OFF
LUMINÁRIAS DE EXTERIOR *QADIR* REGULÁVEL
0-10V/PWM/DIM-TO-OFF



MOSO



100W

711003010CWR	5700 K	14500 Lm
711003010NWR	4000 K	14300 Lm
711003010WWR	2700 K	14100 Lm
711003070CWR	5700 K	14500 Lm
711003070NWR	4000 K	14300 Lm
711003070WWR	2700 K	14100 Lm



120W

711203010CWR	5700 K	17400 Lm
711203010NWR	4000 K	17160 Lm
711203010WWR	2700 K	16920 Lm
711203070CWR	5700 K	17400 Lm
711203070NWR	4000 K	17160 Lm
711203070WWR	2700 K	16920 Lm



140W

711403010CWR	5700 K	20300 Lm
711403010NWR	4000 K	20020 Lm
711403010WWR	2700 K	19740 Lm
711403070CWR	5700 K	20300 Lm
711403070NWR	4000 K	20020 Lm
711403070WWR	2700 K	19740 Lm



DRIVER REGULABLE MOSO X6-150

DRIVER REGULÁVEL MOSO X6-75



Regulación 0-10 vac, PWM, dim to off
Regulação 0-10 vac, PWM, dim to off

Programación offline
Programação off-line

Temporizador
Cronómetro

PROTECCIONES DEL DRIVER
PROTEÇÕES DO DRIVER

OVP	Protección contra sobretensión Proteção contra sobretensão
SCP	Protección contra cortocircuitos Proteção contra curto-circuito
OTP	Protección contra sobrecalentamiento Proteção contra superaquecimento

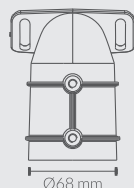
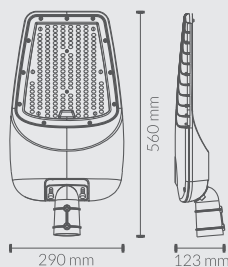

Opcional:

Opcional

710000 Protector sobretensión 10kv.
Protetor sobretensão 10kv.

Otros acabados Ral bajo pedido.
Outros acabamentos Ral sob consulta.



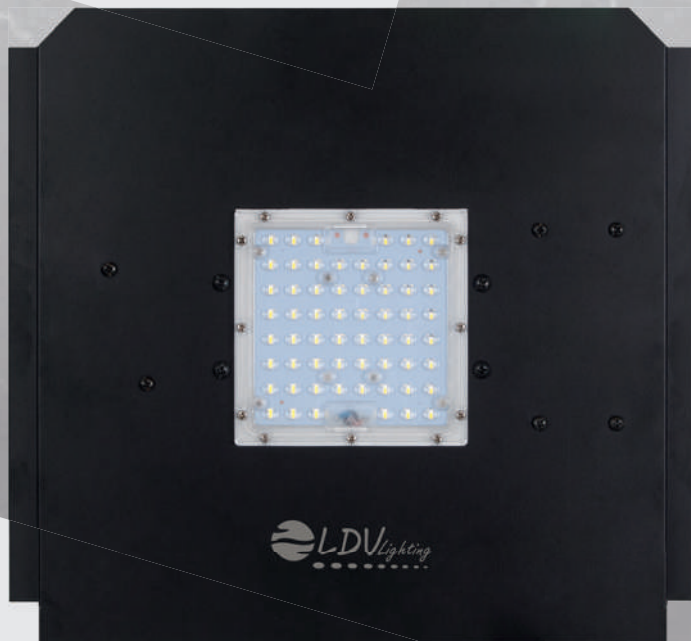

MÓDULO LED LUXOR

MÓDULO DE LED LUXOR



SMD2835



130lm/W



40W

704070CW	5700 K	5200 Lm	N	 Óptica asimétrica Óptica assimétrica
704070NW	4000 K	5120 Lm	N	
704070WW	3000 K	5040 Lm	N	
704070AM	2200 K	4960 Lm	N	

704090CW	5700 K	5200 Lm	N	 Óptica simétrica Óptica simétrica
704090NW	4000 K	5120 Lm	N	
704090WW	3000 K	5040 Lm	N	
704090AM	2200 K	4960 Lm	N	

50W

705070CW	5700 K	6500 Lm	N	 Óptica asimétrica Óptica assimétrica
705070NW	4000 K	6400 Lm	N	
705070WW	3000 K	6300 Lm	N	
705070AM	2200 K	6200 Lm	N	

705090CW	5700 K	6500 Lm	N	 Óptica simétrica Óptica simétrica
705090NW	4000 K	6400 Lm	N	
705090WW	3000 K	6300 Lm	N	
705090AM	2200 K	6200 Lm	N	

60W

706070CW	5700 K	7800 Lm	N	 Óptica asimétrica Óptica assimétrica
706070NW	4000 K	7680 Lm	N	
706070WW	3000 K	7560 Lm	N	
706070AM	2200 K	7440 Lm	N	

706090CW	5700 K	7800 Lm	N	 Óptica simétrica Óptica simétrica
706090NW	4000 K	7680 Lm	N	
706090WW	3000 K	7560 Lm	N	
706090AM	2200 K	7440 Lm	N	

DISEÑADO Y ENSAMBLADO EN ESPAÑA

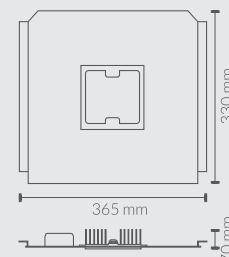

Opcional:

- 700000 Protector sobretensión 10kv.
Protetor sobretensão 10kv.
- Possibilidade de fabricação a medida.
Possibilidade de fabricação sob encomenda.

PROTECCIONES DEL DRIVER

PROTEÇÕES DO DRIVER

- OVP** Protección contra sobretensión
Proteção contra sobretensão
- SCP** Protección contra cortocircuitos
Proteção contra curto-circuito
- OTP** Protección contra sobrecalentamiento
Proteção contra superaquecimento



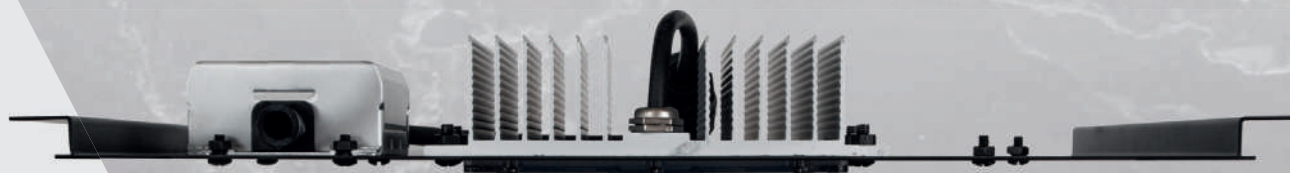

N Negro / Preto



Conector IP67
Conector IP67

Soporte lateral
Apoio lateral



130lm/W

DISEÑADO Y ENSAMBLADO
ESPAÑA

MÓDULO LED *LUXOR* REGULABLE 0-10V/PWM/DIM-TO-OFF/TEMPORIZADOR

MÓDULO DE LED *LUXOR* REGULÁVEL
0-10V/PWM/DIM-TO-OFF/CRONÔMETRO

MOSO **LUMILEDS**
The Brighter Choice
SMD2835

40W

704070CWR	5700 K	5200 Lm	N	
704070NWR	4000 K	5120 Lm	N	
704070WWR	3000 K	5040 Lm	N	
704070AMR	2200 K	4960 Lm	N	

Óptica asimétrica
Óptica assimétrica

704090CWR	5700 K	5200 Lm	N	
704090NWR	4000 K	5120 Lm	N	
704090WWR	3000 K	5040 Lm	N	
704090AMR	2200 K	4960 Lm	N	

Óptica simétrica
Óptica simétrica

50W

705070CWR	5700 K	6500 Lm	N	
705070NWR	4000 K	6400 Lm	N	
705070WWR	3000 K	6300 Lm	N	
705070AMR	2200 K	6200 Lm	N	

Óptica asimétrica
Óptica assimétrica

705090CWR	5700 K	6500 Lm	N	
705090NWR	4000 K	6400 Lm	N	
705090WWR	3000 K	6300 Lm	N	
705090AMR	2200 K	6200 Lm	N	

Óptica simétrica
Óptica simétrica

60W

706070CWR	5700 K	7800 Lm	N	
706070NWR	4000 K	7680 Lm	N	
706070WWR	3000 K	7560 Lm	N	
706070AMR	2200 K	7440 Lm	N	

Óptica asimétrica
Óptica assimétrica

706090CWR	5700 K	7800 Lm	N	
706090NWR	4000 K	7680 Lm	N	
706090WWR	3000 K	7560 Lm	N	
706090AMR	2200 K	7440 Lm	N	

Óptica simétrica
Óptica simétrica

DRIVER REGULABLE PHC-60

DRIVER REGULÁVEL PHC-60

MOSO

Regulación 0-10v, PWM, dim to off, temporizador
Regulação 0-10v, PWM, dim to off, cronômetro

Programación offline

Programação off-line

Temporizador

Cronômetro

PROTECCIONES DEL DRIVER

PROTEÇÕES DO DRIVER

OVP	Protección contra sobretensión Proteção contra sobretensão
SCP	Protección contra cortocircuitos Proteção contra curto-circuito
OTP	Protección contra sobrecalentamiento Proteção contra superaquecimento

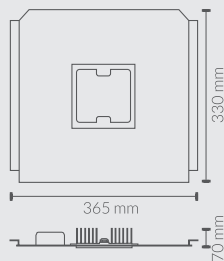

Opcional:

Opcional

700000 Protector sobretensión 10kv.
Protetor sobretensão 10kv.

Posibilidad de fabricación a medida.
Possibilidade de fabricação sob encomenda.



180

TIRAS LED

FITAS DE LED

TIRAS LED 24VDC IP20

FITAS DE LED 24VDC IP20



2835 120D 10,5 W/MT DC24V

San'an
SMD2835

120lm/W

283512020CW	5700 K	10,5 W/mt	1260 Lm/mt	8 mm
283512020NW	4000 K	10,5 W/mt	1239 Lm/mt	8 mm
283512020WW	3000 K	10,5 W/mt	1208 Lm/mt	8 mm
283512020AM	2200 K	10,5 W/mt	1166 Lm/mt	8 mm

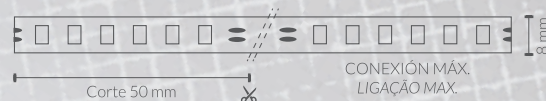

2835 180D 15,5 W/MT DC24V

San'an
SMD2835

120lm/W

283518020CW	5700 K	15,5 W/mt	1860 Lm/mt	10 mm
283518020NW	4000 K	15,5 W/mt	1829 Lm/mt	10 mm
283518020WW	3000 K	15,5 W/mt	1783 Lm/mt	10 mm
283518020AM	2200 K	15,5 W/mt	1720 Lm/mt	10 mm

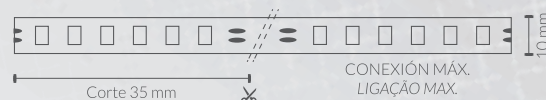

COB 320D 10 W/MT DC24V

San'an
COB

105lm/W

320COB20CW	5700 K	10,0 W/mt	1050 Lm/mt	8 mm
320COB20NW	4000 K	10,0 W/mt	1020 Lm/mt	8 mm
320COB20WW	3000 K	10,0 W/mt	990 Lm/mt	8 mm
320COB20AM	2200 K	10,0 W/mt	960 Lm/mt	8 mm

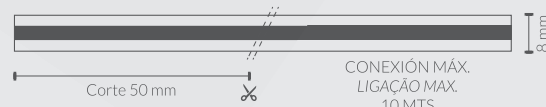

TIRAS LED 24VDC IP20

FITAS DE LED 24VDC IP20



5050 60D 14 W/MT DC24V

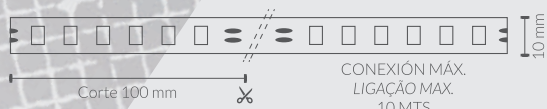

50506020RGB RGB 14,0 W/mt 1150 Lm/mt 10 mm



ACCESORIOS IP20

ACESSÓRIOS IP20

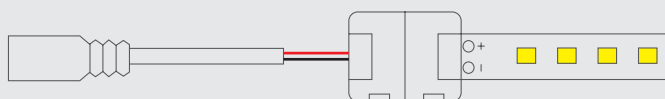

2490000 Cable conexión DC Hembra con conector 2 Pin para tira led 8 mm
DC cabo de conexão fêmea com conector 2 pinos para tira led de 8 mm

2490001 Cable conexión DC Hembra con conector 2 Pin para tira led 10 mm
DC cabo de conexão fêmea com conector 2 pinos para tira led de 10 mm

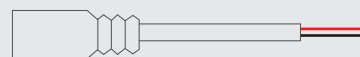

2490002 Cable conexión DC Hembra para tira led 2 Pin
Cabo de conexão fêmea DC para fita led 2 pinos



2490003 Cable conexión DC macho para tira led 2 Pin
Cabo de conexão macho DC para fita led 2 pinos



2490004 Conector 2 PIN para tira de led 8 mm
Conector de 2 pinos para fita led de 8 mm

2490005 Conector 2 PIN para tira de led 10 mm
Conector de 2 pinos para fita led de 10 mm

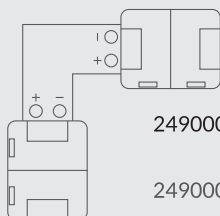
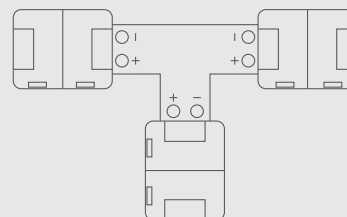

2490006 Conector L 2 PIN para tira de led 8 mm
Conector L de 2 pinos para fita led de 8 mm

2490007 Conector L 2 PIN para tira de led 10 mm
Conector L de 2 pinos para fita led de 10 mm

2490008 Conector T 2 PIN para tira de led 8 mm
Conector T de 2 pinos para fita led de 8 mm

2490009 Conector T 2 PIN para tira de led 10 mm
Conector de 2 pinos para fita led de 10 mm



2490010 Cable conexión 2 tiras 2 PIN 8mm
Cabo de conexão 2 tiras 2 PIN 8mm

2490011 Cable conexión 2 tiras 2 PIN 10mm
Cabo de conexão 2 tiras 2 PIN 10mm

ACCESORIOS IP20

ACESSÓRIOS IP20



2490012 Cable conexión DC hembra/macho con conector 4 Pin
Cabo de conexão DC fêmea/macho com conector de 4 pinos

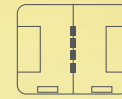

2490015 Conector 4 PIN para tira de led 10 mm
Conector de 4 pinos para fita led de 10 mm



2490013 Cable conexión DC macho con conector 4 Pin 10mm
Cabo de conexão DC macho com conector de 4 pinos 10 mm

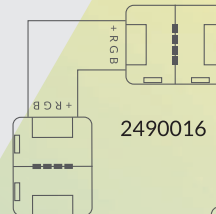

2490016 Conector L 4 PIN para tira de led 10 mm
Conector L de 4 pinos para fita led de 10 mm

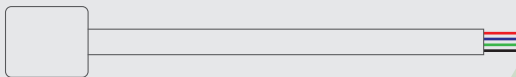

2490014 Cable conexión DC hembra con conector 4 Pin 10mm
Cabo de conexão DC fêmea com conector de 4 pinos 10 mm

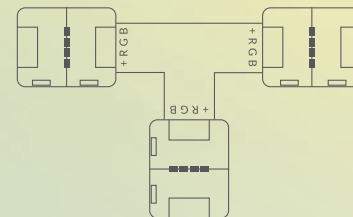

2490017 Conector T 4 PIN para tira de led 10 mm
Conector T de 4 pinos para fita led de 10 mm



2490018 Cable conexión 2 tiras 4 PIN 10 mm
Cabo de conexão 2 tiras 4 PIN 10 mm

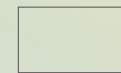

2490019 Tapa final 8 mm/10 mm
Tampa final 8 mm/10 mm

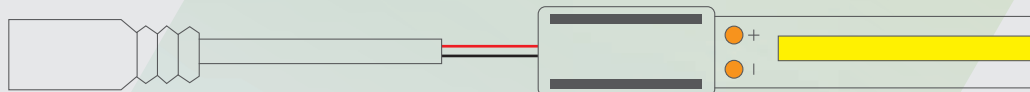

2490020 Cable conexión DC hembra con conector 8 mm para tira COB
Cabo de conexão fêmea DC com conector de 8 mm para tira COB

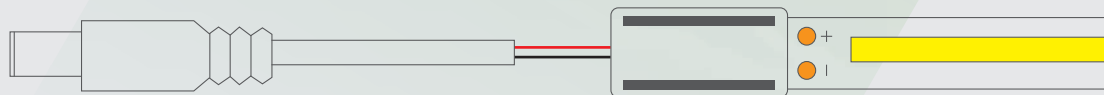

2490021 Cable conexión DC macho con conector 8 mm para tira COB
Cabo de conexão macho DC com conector de 8 mm para tira COB



2490022 Conector 2 tiras 8 mm para tira COB
Conector 2 tiras 8 mm para tira COB

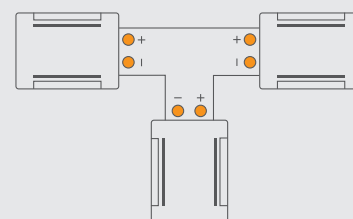

2490024 Conector T 4 8 mm para tira COB
Conector T 4 8 mm para tira COB

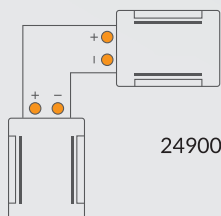

2490023 Conector L 4 8 mm para tira COB
Conector L 4 8 mm para tira COB

TIRAS LED 24VDC IP67

FITAS DE LED 24VDC IP67

ROLLO
5 MTS

2835 120D 10,5 W/MT DC24V

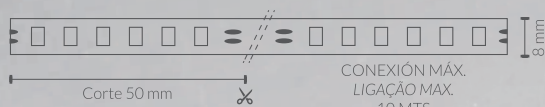
120lm/W

Corte 50 mm

CONEXIÓN MÁX.
LIGAÇÃO MÁX.
10 MTS

283512067CW	5700 K	10,5 W/mt	1260 Lm/mt	8 mm
283512067NW	4000 K	10,5 W/mt	1239 Lm/mt	8 mm
283512067WW	3000 K	10,5 W/mt	1208 Lm/mt	8 mm
283512067AM	2200 K	10,5 W/mt	1166 Lm/mt	8 mm

ROLLO
5 MTS

2835 180D 15,5 W/MT DC24V

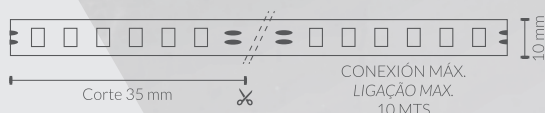
120lm/W

Corte 35 mm

CONEXIÓN MÁX.
LIGAÇÃO MÁX.
10 MTS

283518067CW	5700 K	15,5 W/mt	1860 Lm/mt	10 mm
283518067NW	4000 K	15,5 W/mt	1829 Lm/mt	10 mm
283518067WW	3000 K	15,5 W/mt	1783 Lm/mt	10 mm
283518067AM	2200 K	15,5 W/mt	1720 Lm/mt	10 mm

ROLLO
5 MTS

COB 320D 10 W/MT DC24V

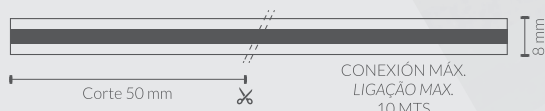
105lm/W

Corte 50 mm

CONEXIÓN MÁX.
LIGAÇÃO MÁX.
10 MTS

320COB67CW	5700 K	10,0 W/mt	1050 Lm/mt	10 mm
320COB67NW	4000 K	10,0 W/mt	1020 Lm/mt	10 mm
320COB67WW	3000 K	10,0 W/mt	990 Lm/mt	10 mm
320COB67AM	2200 K	10,0 W/mt	960 Lm/mt	10 mm

FUNCIÓN DE
MEMORIA

DC24V



120°

CRI
>80

-20%/40°

IP
67

TIRAS LED 24VDC IP20

FITAS DE LED 24VDC IP20



5050 60D 14 W/MT DC24V



50506067RGB

RGB

14,0 W/mt

1150 Lm/mt

10 mm

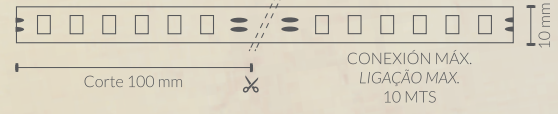

ACCESORIOS IP67

ACESSÓRIOS IP67

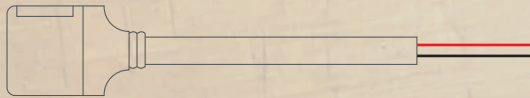

2490025 Cable conexión IP67 2 Pin 8mm
Cabo de conexão IP67 2 pinos 8mm

2490026 Cable conexión IP67 2 Pin 10mm
Cabo de conexão IP67 2 pinos 10mm

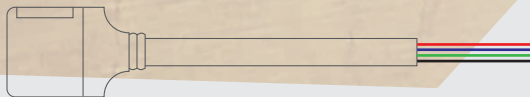

2490033 Cable conexión IP67 4 Pin 10mm
Cabo de conexão IP67 4 pinos 10mm



2490035 Cable conexión IP67 2 Pin 8mm COB
Cabo de conexão IP67 2 pinos 8mm COB

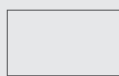

2490029 Tapa final IP67 8mm
Tampa final IP67 8mm

2490030 Tapa final IP67 10mm
Tampa final IP67 10mm



2490031 Clip 8mm
Clipe 8mm

2490032 Clip 10mm
Clipe 10mm

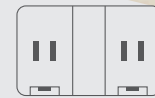

2490027 Conector 2 tiras IP67 2 Pin 8mm
Conector 2 tiras IP67 2 pinos 8mm

2490028 Conector 2 tiras IP67 2 pin 10mm
Conector 2 tiras IP67 2 pinos 10mm



2490034 Conector 2 tiras IP67 4 pin 10mm
Conector 2 tiras IP67 4 pinos 10mm



2490036 Conector 2 tiras IP67 4 Pin 8mm COB
Conector 2 tiras IP67 4 pinos 8mm COB



2490038 Pegamento de silicona para tira LED
Adesivo de silicone para fita LED

TRANSFORMADORES CON ENCHUFE TRANSFORMADORES DE LIGAÇÃO A TOMADA ELÉCTRICA



844107 Transformador 72W 24V 3A con enchufe
Transformador de 72W 24V 3A de ligação a tomada eléctrica



844108 Transformador 72W 24V 3A con enchufe y mando 24k
Transformador de 72W 24V 3A de ligação a tomada eléctrica e comando 24k



FUENTES DE ALIMENTACIÓN FONTES DE ALIMENTAÇÃO

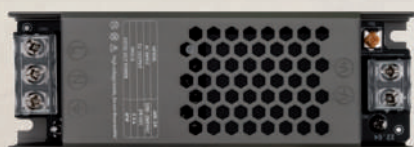

844526 60W 24V 2,5A 145 x 50 x 30 mm



844527 100W 24V 4,2A 162 x 50 x 30 mm



844528 150W 24V 6,25A 162 x 60 x 30 mm



844529 200W 24V 8,3A 188 x 60 x 30 mm

CONTROLADORES PARA TIRAS DE LED 24VDC CONTROLADORES PARA FITAS DE LED 24VDC



844109 Controlador para Tira LED Monocolor 12-24 VDC 6A con mando
Controlador para Fita LED Monocolor 12-24 VDC 6A com comando



844110 Controlador Mini para Tira LED RGB 12-24 VDC 6A con mando
Controlador Mini para Fita LED RGB 12-24 VDC 6A com comando



844113 Controlador para Tira LED RGB 12-24 VDC 18A con mando táctil
Controlador para Fita LED RGB 12-24 VDC 18A com comando touch



844158 Controlador WIFI TUYA APP para Tira LED RGB 12-24 VDC 6A con mando
Controlador WIFI TUYA APP para Fita LED RGB 12-24 VDC 6A com comando

KITS TIRAS DE LED 2835 120D 10,5W DC24V IP20
KITS DE FITA DE LED 2835 120D 10,5 W DC24V IP20

KIT-1 TIRA DE LED 2835 120D 10,5W
DC24V IP20 5MTS + TRANSFORMADOR 72W
CON ENCHUFE

KIT-1 FITA DE LED 2835 120D 10,5W DC24V IP20 5MTS
+ TRANSFORMADOR DE 72W COM TOMADA



120lm/W

K1-2835120CW	5700 K	10,5 W/mt	1260 Lm/mt	8 mm
K1-2835120NW	4000 K	10,5 W/mt	1239 Lm/mt	8 mm
K1-2835120WW	3000 K	10,5 W/mt	1208 Lm/mt	8 mm
K1-2835120AM	2200 K	10,5 W/mt	1166 Lm/mt	8 mm

Incluye / Inclui:
844107

Transformador 72 W 24V 3A con enchufe
Transformador de 72 W 24V 3A com ligação a tomada eléctrica



KIT-2 TIRA DE LED 2835 120D 10,5W
DC24V IP20 5MTS + TRANSFORMADOR 72W
CON ENCHUFE + CONTROLADOR

KIT-2 FITA DE LED 2835 120D 10,5W DC24V IP20 5MTS
+ TRANSFORMADOR DE 72W COM TOMADA + CONTROLADOR



120lm/W

K2-2835120CW	5700 K	10,5 W/mt	1260 Lm/mt	8 mm
K2-2835120NW	4000 K	10,5 W/mt	1239 Lm/mt	8 mm
K2-2835120WW	3000 K	10,5 W/mt	1208 Lm/mt	8 mm
K2-2835120AM	2200 K	10,5 W/mt	1166 Lm/mt	8 mm

Incluye / Inclui:
844107

Transformador 72 W 24V 3A con enchufe
Transformador de 72 W 24V 3A com ligação a tomada eléctrica

844109

Controlador para Tira de LED Monocolor
12-24 VDC 6A con mando
Controlador para Fita LED Monocromática 12-24 VDC 6A
com comando

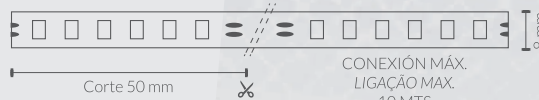

KITS TIRAS DE LED 2835 180D 15,5W DC24V IP20

KITS DE Fita DE LED 2835 180D 15,5 W DC24V IP20

KIT-1 TIRA DE LED 2835 180D 15,5W DC24V IP20 5MTS + TRANSFORMADOR 72W CON ENCHUFE

KIT-1 FITA DE LED 2835 180D 15,5W DC24V IP20 5MTS + TRANSFORMADOR DE 72W COM TOMADA



120lm/W



K1-2835180CW	5700 K	15,5 W/mt	1860 Lm/mt	10 mm
K1-2835180NW	4000 K	15,5 W/mt	1829 Lm/mt	10 mm
K1-2835180WW	3000 K	15,5 W/mt	1783 Lm/mt	10 mm
K1-2835180AM	2200 K	15,5 W/mt	1720 Lm/mt	10 mm

Incluye / Inclui:
844107

Transformador 72 W 24V 3A con enchufe
Transformador de 72 W 24V 3A com ligação a tomada eléctrica



KIT-2 TIRA DE LED 2835 180D 15,5W DC24V IP20 5MTS + TRANSFORMADOR 72W CON ENCHUFE + CONTROLADOR

KIT-2 FITA DE LED 2835 180D 15,5W DC24V IP20 5MTS + TRANSFORMADOR DE 72W COM TOMADA + CONTROLADOR

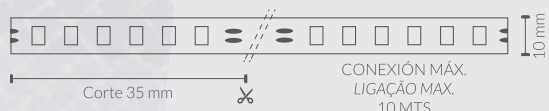

120lm/W



K2-2835180CW	5700 K	15,5 W/mt	1860 Lm/mt	10 mm
K2-2835180NW	4000 K	15,5 W/mt	1829 Lm/mt	10 mm
K2-2835180WW	3000 K	15,5 W/mt	1783 Lm/mt	10 mm
K2-2835180AM	2200 K	15,5 W/mt	1720 Lm/mt	10 mm

Incluye / Inclui:
844107

Transformador 72 W 24V 3A con enchufe
Transformador de 72 W 24V 3A com ligação a tomada eléctrica

844109

Controlador para Tira de LED Monocolor 12-24 vdc 6A con mando
Controlador para Fita LED Monocromática 12-24 VDC 6A com comando



TIRAS LED

FITAS DE LED

KITS TIRAS DE LED COB 320D 10W DC24V IP20 KITS DE FITA DE LED COB 320D 10W DC24V IP20

KIT-1 TIRA DE LED COB 320D 10W DC24V IP20 5MTS + TRANSFORMADOR 72W CON ENCHUFE

KIT-1 FITA DE LED COB 320D 10W DC24V IP20 5MTS
+ TRANSFORMADOR DE 72W COM TOMADA



105lm/W

K1-320COBCW	5700 K	10,0 W/mt	1050 Lm/mt	8 mm
K1-320COBNW	4000 K	10,0 W/mt	1020 Lm/mt	8 mm
K1-320COBWW	3000 K	10,0 W/mt	990 Lm/mt	8 mm
K1-320COBAM	2200 K	10,0 W/mt	960 Lm/mt	8 mm

Incluye / Inclui:
844107

Transformador 72 W 24V 3A con enchufe
Transformador de 72 W 24V 3A com ligação a tomada eléctrica

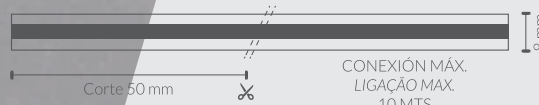

KIT-2 TIRA DE LED COB 320D 10W DC24V IP20 5MTS + TRANSFORMADOR 72W CON ENCHUFE + CONTROLADOR

KIT-1 FITA DE LED COB 320D 10W DC24V IP20 5MTS
+ TRANSFORMADOR DE 72W COM TOMADA + CONTROLADOR



105lm/W

K2-320COBCW	5700 K	10,0 W/mt	1050 Lm/mt	8 mm
K2-320COBNW	4000 K	10,0 W/mt	1020 Lm/mt	8 mm
K2-320COBWW	3000 K	10,0 W/mt	990 Lm/mt	8 mm
K2-320COBAM	2200 K	10,0 W/mt	960 Lm/mt	8 mm

Incluye / Inclui:
844107

Transformador 72 W 24V 3A con enchufe
Transformador de 72 W 24V 3A com ligação a tomada eléctrica

844109

Controlador para Tira de LED Monocolor
12-24 VDC 6A con mando
Controlador para Fita LED Monocromática 12-24 VDC 6A
com comando

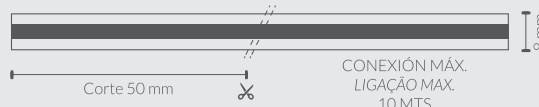

KITS TIRAS DE LED SMD5050 60D 14W RGB DC24V IP20

KITS DE FITA DE LED SMD5050 60D 14W RGB DC24V IP20

KIT-1 TIRA DE LED SMD5050 60D 14W RGB DC24V IP20 5MTS + TRANSFORMADOR 72W Y CONTROLADOR CON ENCHUFE

KIT-1 FITA DE LED SMD5050 60D 14W RGB DC24V IP20 5MTS + TRANSFORMADOR DE 72W E COMANDO COM TOMADA

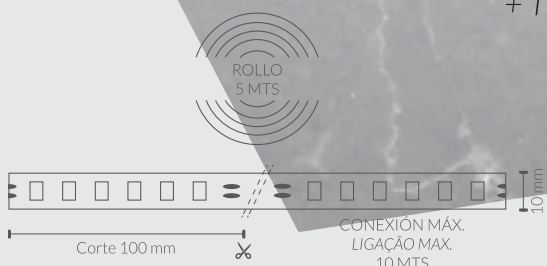

K1-505060RGB RGB 14,0 W/mt 1150 Lm/mt 10 mm
Incluye / Inclui:
844108

Transformador 72 W 24V 3A con enchufe y con mando 24k
 Transformador de 72W 24V 3A de ligação a tomada eléctrica e comando 24k



KIT-2 TIRA DE LED SMD5050 60D 14W RGB DC24V IP20 5MTS + TRANSFORMADOR 72W CON ENCHUFE + CONTROLADOR MINI RGB

KIT-2 FITA DE LED SMD5050 60D 14W RGB DC24V IP20 5MTS + TRANSFORMADOR DE 72W COM TOMADA + CONTROLADOR MINI RGB

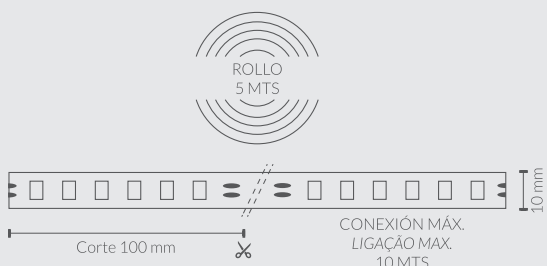

K2-505060RGB RGB 14,0 W/mt 1150 Lm/mt 10 mm
Incluye / Inclui:
844107
844110

Transformador 72 W 24V 3A con enchufe
 Transformador de 72 W 24V 3A con ligação a tomada eléctrica
 Controlador MINI para Tira de LED RGB 12-24 VDC 6A con mando
 Controlador MINI para Fita LED RGB 12-24 VDC 6A com comando



KITS TIRAS DE LED SMD5050 60D 14W RGB DC24V IP20

KITS DE FITA DE LED SMD5050 60D 14W RGB DC24V IP20

KIT-3 TIRA DE LED SMD5050 60D 14W RGB DC24V IP20 5MTS + TRANSFORMADOR 72W CON ENCHUFE + CONTROLADOR WIFI RGB

KIT-3 FITA DE LED SMD5050 60D 14W RGB DC24V IP20 5MTS + TRANSFORMADOR DE 72W COM TOMADA + CONTROLADOR WIFI RGB



K3-505060RGB RGB 14,0 W/mt 1150 Lm/mt 10 mm

Incluye / Inclui:

844107

Transformador 72 W 24V 3A con enchufe
Transformador de 72 W 24V 3A com ligação a tomada eléctrica

844158

Controlador WIFI TUYA APP para Tira de LED RGB 12-24 VDC 6A con mando
Controlador WIFI TUYA APP para Fita LED RGB 12-24 VDC 6A com comando

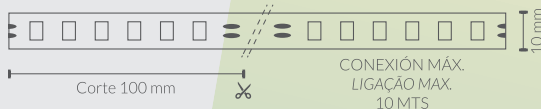

KIT-4 TIRA DE LED SMD5050 60D 14W RGB DC24V IP20 5MTS + TRANSFORMADOR 72W CON ENCHUFE + CONTROLADOR CON MANDO TÁCTIL

KIT-4 FITA DE LED SMD5050 60D 14W RGB DC24V IP20 5MTS + TRANSFORMADOR DE 72W COM TOMADA + COM COMANDO TOUCH



K4-505060RGB RGB 14,0 W/mt 1150 Lm/mt 10 mm

Incluye / Inclui:

844107

Transformador 72 W 24V 3A con enchufe
Transformador de 72 W 24V 3A com ligação a tomada eléctrica

844113

Controlador para Tira de LED RGB 12-24 VDC 18A con mando táctil
Controlador para Fita LED RGB 12-24 VDC 18A com comando touch

249014

Cable conexión DC hembra 4 Pin 10 mm
Cabo de conexão DC fêmea com conector de 4 pinos 10 mm

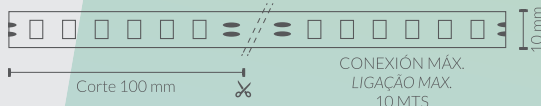

PERFILES DE ALUMINIO PARA TIRAS LED

PERFIS DE ALUMÍNIO PARA FITA DE LED



2490039 Perfil aluminio para Tira LED con difusor
Perfil de aluminio para Fita LED con difusor

2000 x 170 x 7 mm

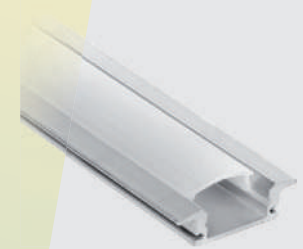

2490040 Perfil aluminio de empotrar para Tira LED con difusor
Perfil de aluminio de encastrar para Fita LED con difusor

2000 x 250 x 7 mm



2490041 Perfil aluminio angular para Tira LED con difusor
Perfil de aluminio angular para Fita LED con difusor

2000 x 250 x 7 mm

TIRAS LED

FITAS DE LED

TIRAS LED 220-240VAC FITAS DE LED 220-240VAC



TIRAS DE LED MONOCOLOR 220-240VAC FITAS DE LED MONOCOLOR 220-240VAC

SMD5050

7,2W/MT 2PIN

505060CW 6000 K 720 Lm/mto PCB 8 mm
505060WW 3000 K 690 Lm/mto PCB 8 mm



TIRAS DE LED RGB 220-240VAC FITAS DE LED RGB 220-240VAC

SMD5050

15W/MT 4PIN

505060RGB RGB 900 Lm/mto PCB 10 mm



TIRAS DE LED CCT 220-240VAC FITAS DE LED CCT 220-240VAC

SMD5730

15W/MT 3PIN

5730120CWW CCT 900 Lm/mto PCB 12 mm



ACCESORIOS 220-240VAC
ACESSÓRIOS 220-240VAC

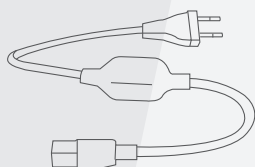

CABLE RECTIFICADOR
CABO RETIFICADOR

505021

Cable rectificador 2 pin máx. 50 mts
Cabo retificador 2 pin max. 50 mts

573031

Cable rectificador 3 pin máx. 50 mts
Cabo retificador 3 pin max. 50 mts

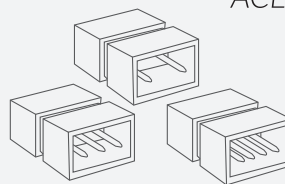

CONECTOR
CONECTOR

505022

Conector 2 pin
Conector de 2 pinos

573032

Conector 3 pin
Conector de 3 pinos

505042

Conector 4 pin
Conector de 4 pinos



CLIP PARA TIRA
CLIFE PARA TIRA

505024

Clip para tira 8 mm
Clife para tira 8 mm

573034

Clip para tira 10-12 mm
Clife para tira 10-12 mm



CONECTOR
C/ CABLE FLEXIBLE
CONECTOR DE CABO FLEXÍVEL

505027

Conector c/ cable flexible 2 pin
Conector de cabo flexível de 2 pinos

573037

Conector c/ cable flexible 3 pin
Conector de cabo flexível de 3 pinos

505047

Conector c/ cable flexible 4 pin
Conector de cabo flexível de 4 pinos

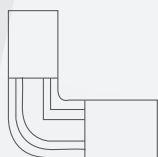

CONECTOR ÁNGULO
CONECTOR DE ÂNGULO

505023

Conector ángulo 2pin
Conector de ángulo de 2 pinos

PERFIL PLÁSTICO PARA TIRA
PERFIL PLÁSTICO PARA TIRA

505025

Perfil plástico para tira 8 mm- 2 mts
Perfil plástico para tira 8 mm - 2mts

573025

Perfil plástico para tira 10 mm- 12 mts
Perfil plástico para tira 10 mm - 12mts

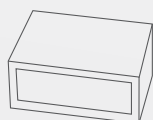

TAPA FINAL PARA TIRA
TAMPA FINAL PARA TIRA

505026

Tapa final para tira 8 mm
Tampa final para tira de 8 mm

573026

Tapa final para tira 10-12 mm
Tampa final para tira de 10-12 mm

CONTROLADOR
REMOTO 4PIN RGB
220V MÁX 25MTS
CONTROLE REMOTO 4PIN RGB
220V MAX 25MTS

505045

Controlador remoto 4pin rgb 220v máx 25 mts
Controle remoto 4pin rgb 220v max 25 mts

CONTROLADOR 4 PIN
TIRA RGB MÁX 50MTS
CONTROLADOR 4PIN RGB TIRA
MAX 50MTS

505041

Controlador 4pin tira rgb máx 50 mts
Controlador 4pin rgb tira max 50 mts

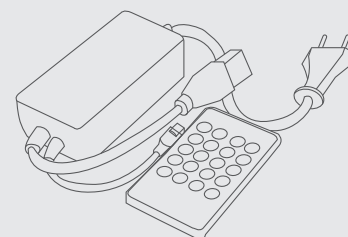
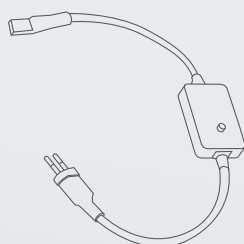

EMPOTRABLE OSCILANTE MINI SPOT LUMINÁRIA DE ENCASTRAR OSCILANTE MINI SPOT

CREE
LEDs
SMD2835

3W - REDONDO

236300NW	4000 K	195 Lm	B
236300WW	3000 K	190 Lm	B

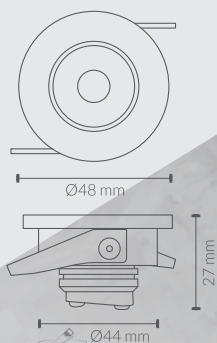

3W - CUADRADO

237300NW	5700 K	195 Lm	B
237300WW	4000 K	190 Lm	B

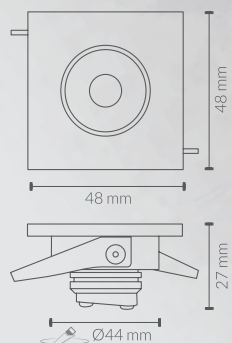

LUMINARIA ROTABLE DE EMPOTRAR

LUMINÁRIA DE ENCASTRAR ROTATIVA

LIFUD
LED Driver

CREE
LEDs
COB1507



9W

230900NW

4000 K

810 Lm

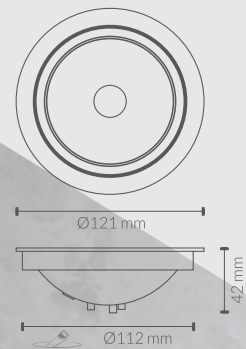

LUMINARIA ROTABLE

DE EMPOTRAR

LUMINÁRIA DE ENCASTRAR ROTATIVA

LIFUD
LED Driver

CREE
LEDs
COB1508



15W

231500NW

4000 K

1350 Lm

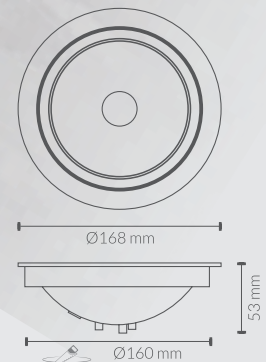

EMPOTRABLES DE TECHO

LUMINÁRIAS DE ENCASTRAR

PROYECTOR RECTANGULAR BASCULANTE PORJETOR BASCULANTE RETANGULAR

CREE
LEDs
SMD2835

Lifud
LED Driver

36W

5663600CW 6000 K 3240 Lm
5663600NW 4500 K 3168 Lm

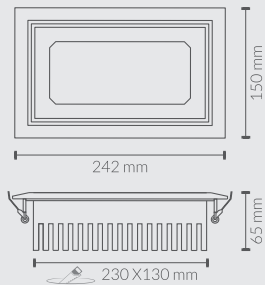

EMPOTRABLE IP65 LUMINÁRIA IP65 DE ENCASTRAR

LUMILEDS
The Brighter Choice
SMD2835

5W

327BL 6000 K 350 Lm **B**
327NK 6000 K 350 Lm **N**

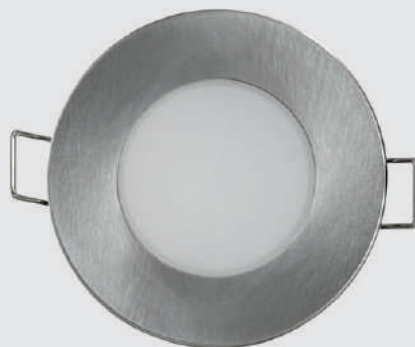
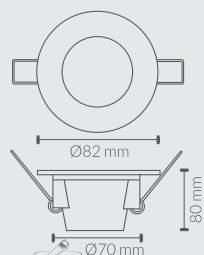

N Níquel / Níquel



B Blanco / Branco

*PA = POLIAMIDA



EMPOTRABLE REDONDO FIJO
LUMINÁRIA DE ENCASTRAR REDONDO FIJO



B Blanco / Branco



N Níquel / Níquel

306BL **B**

306NK **N**

*Incluye PGU10

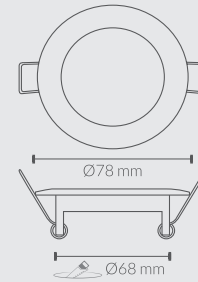

EMPOTRABLE REDONDO OSCILANTE
LUMINÁRIA DE ENCASTRAR REDONDO OSCILANTE



308BL **B**

308NK **N**

*Incluye PGU10

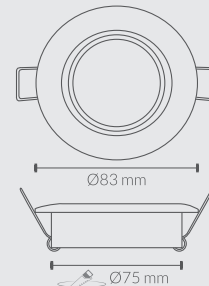

EMPOTRABLE CUADRADO OSCILANTE
LUMINÁRIA DE ENCASTRAR QUADRADO OSCILANTE



310NK **N**

*Incluye PGU10

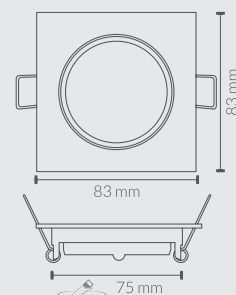

EMPOTRABLES DE TECHO

LUMINÁRIAS DE ENCASTRAR

EMPOTRABLE ALUMINIO REDONDO OSCILANTE

LUMINÁRIA DE ENCASTRAR ALUMINÍO
REDONDO OSCILANTE

325AL **A** 325BL **B** 325NG **N**

*Incluye PGU10

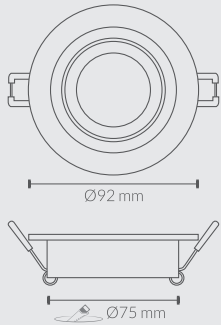

B Blanco / Branco

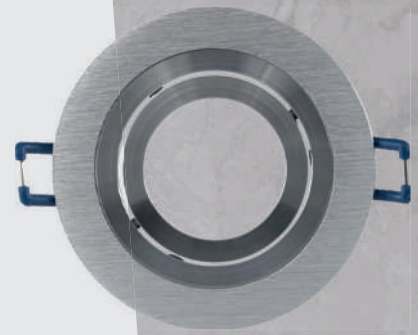

A Aluminio / Alumínio

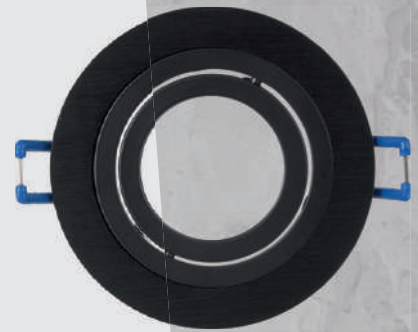

N Negro / Preto

EMPOTRABLE ALUMINIO CUADRADO OSCILANTE

LUMINÁRIA DE ENCASTRAR ALUMINÍO
QUADRADO OSCILANTE

326AL **A** 326BL **B** 326NG **N**

*Incluye PGU10

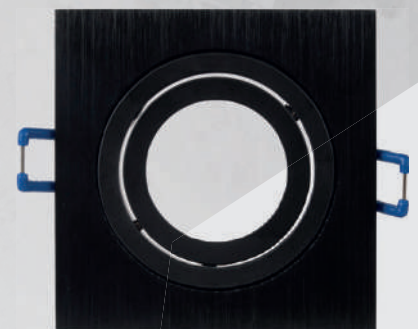
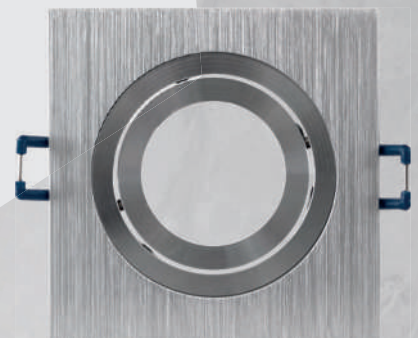
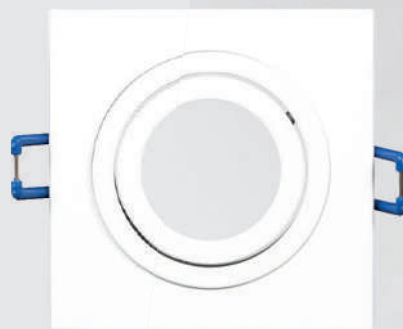
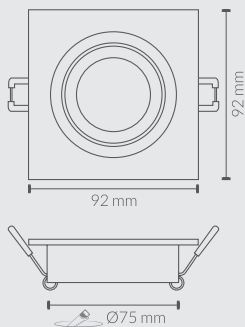

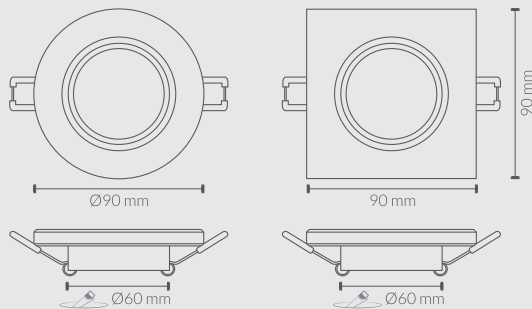

EMPOTRABLE CRISTAL ESPEJO
LUMINÁRIA DE ENCASTRAR CRISTAL ESPELHO

- | | | |
|-------|-----------------------|-------------------|
| 312CE | REDONDO
ARREDONDAR | ESPEJO
ESPELHO |
| 313CE | CUADRADO
QUADRADO | ESPEJO
ESPELHO |

*Incluye PGU10



315NG

N Negro / Preto



316BL

B Blanco / Branco

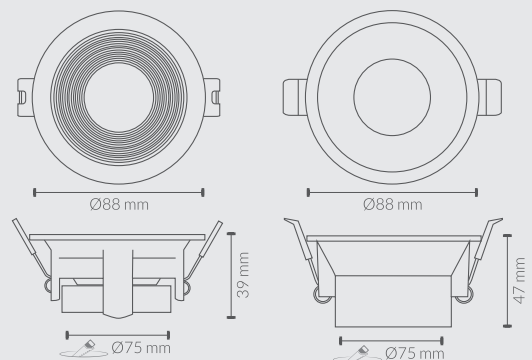

315BL / 315NG

316BL / 316NG

EMPOTRABLE *CONFORT*
LUMINÁRIA DE ENCASTRAR *CONFORT*



- | | | | |
|-------|----------|-------|----------|
| 315BL | B | 315NK | N |
|-------|----------|-------|----------|



- | | | | |
|-------|----------|-------|----------|
| 316BL | B | 316NK | N |
|-------|----------|-------|----------|



EMPOTRABLES DE TECHO

LUMINÁRIAS DE ENCASTRAR

EMPOTRABLE *CARDAN* LUMINÁRIA DE ENCASTRAR *CARDAN*

GU10

- 328BL 1 x GU10
- 329BL 2 x GU10
- 330BL 3 x GU10

B
B
B

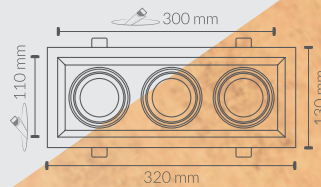
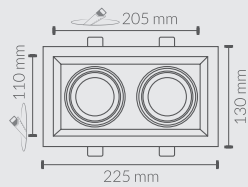
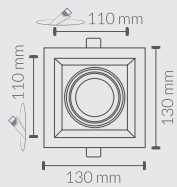

330BL



333BL

AR111

- 331BL 1 x AR111
- 332BL 2 x AR111
- 333BL 3 x AR111

B
B
B

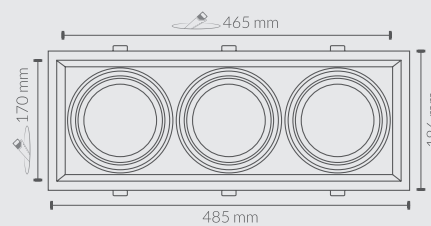
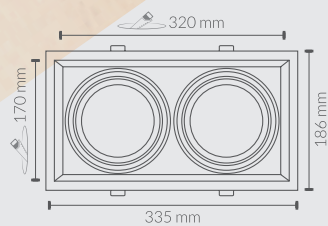
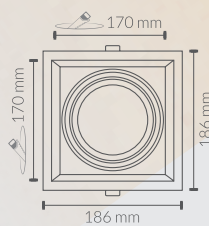



SENSORES DE MOVIMIENTO
SENSORES DE MOVIMIENTO

SENSORES DE MOVIMIENTO DE EMPOTRAR

SENSORES DE MOVIMENTO EMBUTIDOS

- 36000** **B** Carga máxima: 1200w (INCANDESCENCIA) 200w (LED)
Carga máxima 1200w (BRILHO) 200w (LED)
 Campo detección: 6mt (<24°)
Campo de detecção
 Nivel luminosidad: 10-2000lux ajustables
Nível de brilho 10-2000lux ajustável
 Temporización: 10sg-7min ajustables
Tempo 10sg-7min ajustável
 Ángulo detección: 360°
Ângulo de detecção
 Altura instalación: 2,2-4mts
Altura da Instalação

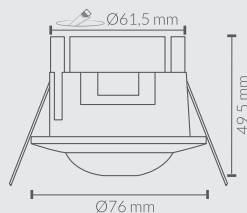

360° Fijo

- 36004** **B** Carga máxima: 1200w (INCANDESCENCIA) 300w (LED)
Carga máxima 1200w (BRILHO) 300w (LED)
 Campo detección: 6mt (<24°)
Campo de detecção
 Nivel luminosidad: 10-2000lux ajustables
Nível de brilho 10-2000lux ajustável
 Temporización: 10sg-15min ajustables
Tempo 10sg-15min ajustável
 Ángulo detección: 360°
Ângulo de detecção
 Altura instalación: 2,2-4mts
Altura da Instalação

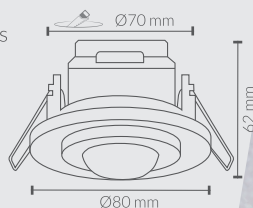

360° Oscilante

- 36001** **B** Carga máxima: 1200w (INCANDESCENCIA) 200w (LED)
Carga máxima 1200w (BRILHO) 200w (LED)
36002 **N** Campo detección: 6mt (<24°)
Campo de detecção
36003 **P** Nivel luminosidad: 10-2000lux ajustables
Nível de brilho 10-2000lux ajustável
 Temporización: 10sg-7min ajustables
Tempo 10sg-7min ajustável
 Ángulo detección: 360°
Ângulo de detecção
 Altura instalación: 2,2-4mts
Altura da Instalação

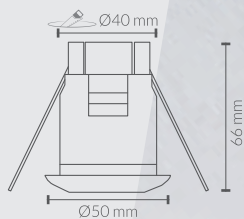

360° Mini



B Blanco / Branco



P Plata / Prata

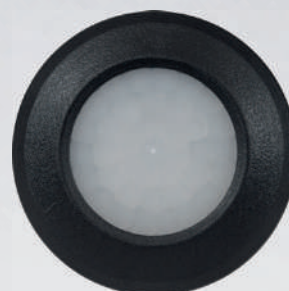

N Negro / Preto



SENSORES DE MOVIMIENTO DE SUPERFICIE
SENSORES DE MOVIMENTO SUPERFÍCIE

TECHO / TETO

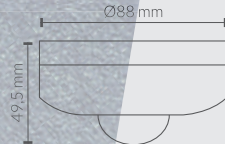

36006	B	Carga máxima:	1200w (INCANDESCENCIA) 200w (LED)
		Carga máxima	1200w (BRILHO) 200w (LED)
		Campo detección:	6mt (<24°)
		Campo de detecção	
		Nivel luminosidad:	10-2000lux ajustables
		Nível de brilho	10-2000lux ajustável
		Temporización:	10sg-7min ajustables
		Tempo	10sg-7min ajustável
		Ángulo detección:	360°
		Ângulo de detecção	
		Altura instalación:	2,2-4mts
		Altura da Instalação	

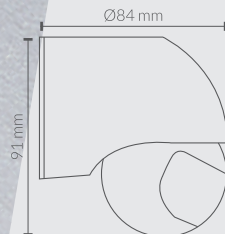

PARED / PAREDE

18006	B	Carga máxima:	1200w (INCANDESCENCIA) 200w (LED)
		Carga máxima	1200w (BRILHO) 200w (LED)
		Campo detección:	6mt (<24°)
		Campo de detecção	
		Nivel luminosidad:	10-2000lux ajustables
		Nível de brilho	10-2000lux ajustável
		Temporización:	10sg-7min ajustables
		Tempo	10sg-7min ajustável
		Ángulo detección:	180°
		Ângulo de detecção	
		Altura instalación:	2,2-4mts
		Altura da Instalação	



PORTALÁMPARAS E27 CON SENSOR CREPUSCULAR
CASQUILHO E27 COM SENSOR CREPUSCULAR



36270	B	Carga máxima:	60w (INCANDESCENCIA Y LED)
		Carga máxima	60w (BRILHO Y LED)
		Campo detección:	8mt (<24°)
		Campo de detecção	
		Valor mínimo de operación:	ON <10LUX - OFF <100LUX
		Valor mínimo de operação	
		Valor máximo de operación:	ON <50LUX - OFF <200LUX
		Valor máximo de operação	
		Ángulo detección:	360°
		Ângulo de detecção	
		Altura instalación:	2,2-4mts
		Altura da Instalação	



PASTILLA REGULADORA PULSACIÓN PARA LED DIMMER DE PULSAÇÃO PARA LED

844233 Potencia de carga: MÁX. 300w
Poder de carregamento
Tipo de carga: PRINCIPIO DE FASE
Tipo de carga: PRINCÍPIO DA FASE
Consumo: 1w
Consumo

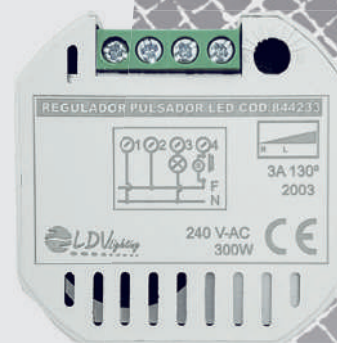
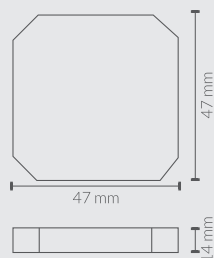

PASTILLA REGULADORA PARA LED SMART DIMMER DE PULSAÇÃO PARA LED SMART

844539 Potencia de carga: MÁX. 150W
Poder de carregamento
Tipo de carga: FINAL DE FASE
Tipo de carga: FINAL DA FASE
Frecuencia WIFI: 2,4GHz - 2,4835GHz
Frequência WIFI: 802,11b/g/n
Consumo: 1w
Consumo
Rango Trabajo <200MTS
Faixa de trabalho



Compatible con: / Compatível com:

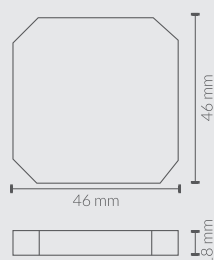

CONTROLADOR LED REMOTO ON/OFF CONTROLADOR DE LED REMOTO ON/OFF

844468 Potencia de carga: MAX. 200W LED
Poder de carregamento
Frecuencia: FRECUENCIA REMOTA 433.92MHz
Frequência: FREQUÊNCIA REMOTA 433,92 MHz
Distancia de alcance mando remoto: MAX. 15MTS
Distância de projeção controle remoto

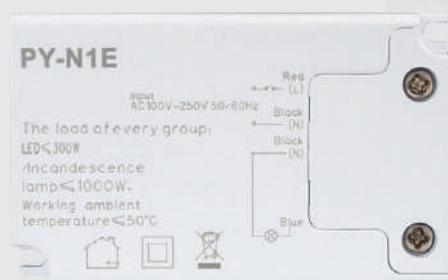
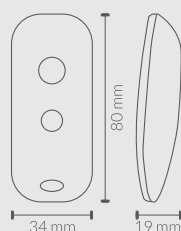

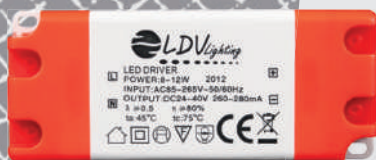

844484	Potencia: 4-7W Poder	Tensión de salida: 12-24vdc Voltagem de saída	Intensidad de tensión de salida: 240-260mA Intensidade da tensão de saída
844485	Potencia: 8-12W Poder	Tensión de salida: 24-40vdc Voltagem de saída	Intensidad de tensión de salida: 260-280mA Intensidade da tensão de saída
844486	Potencia: 13-18W Poder	Tensión de salida: 39-60vdc Voltagem de saída	Intensidad de tensión de salida: 280-300mA Intensidade da tensão de saída
844487	Potencia: 19-24W Poder	Tensión de salida: 57-80vdc Voltagem de saída	Intensidad de tensión de salida: 280-300mA Intensidade da tensão de saída



DRIVERS DIMABLES PARA LED DRIVERS REGULÁVEL DE LED

844330	Potencia: 4-7W Poder	Tensión de salida: 12-24vdc Voltagem de saída	Intensidad de tensión de salida: 300mA Intensidade da tensão de saída
844331	Potencia: 8-12W Poder	Tensión de salida: 25-42vdc Voltagem de saída	Intensidad de tensión de salida: 300mA Intensidade da tensão de saída
844332	Potencia: 13-18W Poder	Tensión de salida: 43-60vdc Voltagem de saída	Intensidad de tensión de salida: 300mA Intensidade da tensão de saída
844333	Potencia: 19-24W Poder	Tensión de salida: 50-75vdc Voltagem de saída	Intensidad de tensión de salida: 300mA Intensidade da tensão de saída



DRIVERS PARA LED IP67 DRIVERS DE LED IP67

844469	Potencia: 50W Poder	Tensión de salida: 12vdc Voltagem de saída	Intensidad de tensión de salida: 4,2A Intensidade da tensão de saída	Medidas: 211x30,5x20,5mm Medidas
844470	Potencia: 100W Poder	Tensión de salida: 12vdc Voltagem de saída	Intensidad de tensión de salida: 8,3A Intensidade da tensão de saída	Medidas: 177x43,6x35,2mm Medidas
844471	Potencia: 150W Poder	Tensión de salida: 12vdc Voltagem de saída	Intensidad de tensión de salida: 12,5A Intensidade da tensão de saída	Medidas: 55x67,7x42x70mm Medidas



KIT DE EMERGENCIA PARA LED KIT DE EMERGÊNCIA DE LED

844795	Carga máxima: 80w DC 2A Poder de carregamento	Tiempo de carga: 12 hrs Tempo de carregamento
Potencia: 3w,4w,5w,6w (seleccionable/selecionável)	Batería: Li-on: 3,7v 2500mh	
Autonomía: 180min, 120min, 90min, Autonomia 60min (según potencia seleccionada/de acordo com a potência selecionada)	Indicadores LED: VERDE: Bateria en funcionamiento ROJO: Bateria en Carga Indicadores LED: VERDE: Bateria em operação VERMELHO: Bateria em carga	

Tension de entrada: DC 10-80v 0-600mA

Tensão de entrada

Tension de salida: AC 100-277v 50-60Hz

Tensão de saída

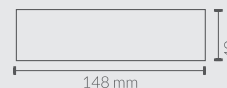

REGLETAS DE CONEXIÓN TIRAS DE CONEXÃO

844235	6mm	12 polos	450V	41A	B
844236	10mm	12 polos	450V	57A	B
844237	16mm	12 polos	450V	76A	B
844238	25mm	12 polos	450V	101A	B

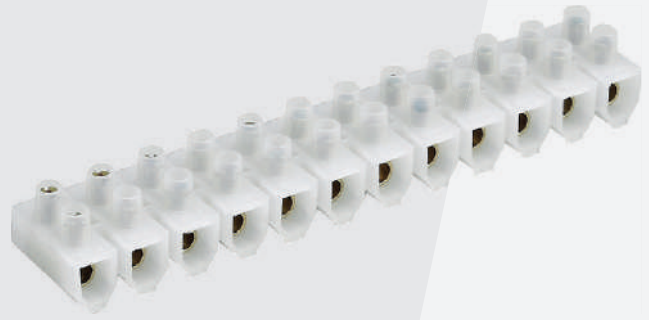

PORTALÁMPARAS CONVERSORES SUPORTE DA LÂMPADA DO CONVERSORES

844239	PORTALÁMPARAS CONVERSION DE E14 A E27
844240	PORTALÁMPARAS CONVERSION DE E27 A E14
844241	PORTALÁMPARAS CONVERSION DE E27 A GU10
844242	PORTALÁMPARAS CONVERSION DE E14 A GU10
844243	PORTALÁMPARAS CONVERSION DE E40 A E27
844244	PORTALÁMPARAS CONVERSION DE E27 A E40
844245	PORTALÁMPARAS CONVERSION DE E27 A G9
844246	PORTALÁMPARAS CONVERSION DE E14 A G9
844343	PORTALÁMPARAS E27 C/CABLE 1MT. NEGRO
844344	PORTALÁMPARAS E27 C/CABLE 1MT. BRONCE

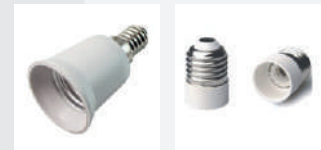

844239

844240



844241

844242

844243

844244



844245

844246

844343

844344

PORTALÁMPARAS GU10 SUPORTE GU10

PGU10 PORTALAMPARAS GU10





BRIDAS DE NYLON ABRAÇADEIRAS DE NYLON

844355	B	Medida: 2,5x100mm A medida	Diámetro min-máx: 2-22 Diámetro mínimo-máximo	Resistencia del bucle (Kgs): 8 Resistència de Loop (Kgs)
844356	N	Medida: 2,5x100mm A medida	Diámetro min-máx: 2-22 Diámetro mínimo-máximo	Resistencia del bucle (Kgs): 8 Resistència de Loop (Kgs)
844357	B	Medida: 2,5x150mm A medida	Diámetro min-máx: 2-35 Diámetro mínimo-máximo	Resistencia del bucle (Kgs): 8 Resistència de Loop (Kgs)
844358	N	Medida: 2,5x150mm A medida	Diámetro min-máx: 2-35 Diámetro mínimo-máximo	Resistencia del bucle (Kgs): 8 Resistència de Loop (Kgs)
844359	B	Medida: 3,6x200mm A medida	Diámetro min-máx: 3-50 Diámetro mínimo-máximo	Resistencia del bucle (Kgs): 18 Resistència de Loop (Kgs)
844360	N	Medida: 3,6x200mm A medida	Diámetro min-máx: 3-50 Diámetro mínimo-máximo	Resistencia del bucle (Kgs): 18 Resistència de Loop (Kgs)
844361	B	Medida: 4,8x200mm A medida	Diámetro min-máx: 3-50 Diámetro mínimo-máximo	Resistencia del bucle (Kgs): 22 Resistència de Loop (Kgs)
844362	N	Medida: 4,8x200mm A medida	Diámetro min-máx: 3-50 Diámetro mínimo-máximo	Resistencia del bucle (Kgs): 22 Resistència de Loop (Kgs)
844363	B	Medida: 4,8x300mm A medida	Diámetro min-máx: 3-82 Diámetro mínimo-máximo	Resistencia del bucle (Kgs): 22 Resistència de Loop (Kgs)
844364	N	Medida: 4,8x300mm A medida	Diámetro min-máx: 3-82 Diámetro mínimo-máximo	Resistencia del bucle (Kgs): 22 Resistència de Loop (Kgs)
844365	B	Medida: 4,8x380mm A medida	Diámetro min-máx: 3-102 Diámetro mínimo-máximo	Resistencia del bucle (Kgs): 22 Resistència de Loop (Kgs)
844366	N	Medida: 4,8x380mm A medida	Diámetro min-máx: 3-102 Diámetro mínimo-máximo	Resistencia del bucle (Kgs): 22 Resistència de Loop (Kgs)

Material: PA66 Poliamida 66 94v-2 UL
Material
Autoextingibilidad: UL 94v-2
auto-extinguível

Temperatura: -20°- 50°
Temperatura
Resistencia UV
Resistència UV



TACO PARA BRIDAS DE NYLON TACO PARA ABRAÇADEIRAS DE NYLON

844587	8mm	N
844588	8mm	B

CERTIFICACIONES

Todos nuestros productos disponen de la certificación CE con las directivas vigentes y la directiva RoHS 2011/65/EU, garantizando la calidad y el cumplimiento de la legislación de todos los artículos fabricados.



Para poder venderse en la UE muchos productos deben llevar obligatoriamente el marcado CE, que demuestra que el fabricante ha evaluado el producto y se considera que este cumple los requisitos de seguridad, sanidad y protección del medio ambiente exigidos por la UE. El marcado CE es obligatorio para los productos fabricados en cualquier lugar del mundo que vayan a **comercializarse en la UE**.



El certificado RoHS, garantiza la Restricción de ciertas Sustancias Peligrosas en aparatos eléctricos y electrónicos.

RoHS, del inglés "Restriction of Hazardous Substances"), entro en vigor en 2006 y restringe el uso de seis materiales peligrosos en la fabricación de varios tipos de equipos eléctricos y electrónicos. La Directiva RoHS de la UE está vinculada estrechamente con la Directiva de residuos eléctricos y electrónicos (RAEE), 2002/96/CE, que establece objetivos de recogida, reciclado y recuperación de aparatos eléctricos.



Todos los productos certificados con ENEC cumplen con la normativa de marcado CE, ya que se ha sometido a un examen completo realizado por agentes independientes que asegura que tiene los requisitos de calidad exigidos y que tanto el producto como la fábrica se seguirá sometiendo a inspecciones periódicas.



20
23

CATÁLOGO
ILUMINACIÓN



(+34) 956 402 349
Avda. del Mueble, 30
11130 Chiclana de la Frontera
Cádiz • España

www.ldvlighting.com